

01.2024  
LISTINO - PRICE LIST



1964  
2024  
**60**  
ANNIVERSARY



**VIGNETO & FRUTTETO**  
VINEYARD & ORCHARD  
WEIN- & OBSTBAU  
VIÑEDOS Y HUERTOS FRUTALES  
VIGNOBLES ET FRUITIERS



**Consulta i nostri listini online per avere gli ultimi aggiornamenti!**

Zanon srl si riserva di apportare variazioni senza alcun preavviso

**Check out our online price lists for the latest updates!**

Zanon srl reserves the right to make changes without prior notice

[zanon.it](http://zanon.it)



**VIGNETO & FRUTTETO**

VINEYARD & ORCHARD  
WEIN- & OBSTBAU  
VIÑEDOS Y HUERTOS FRUTALES  
VIGNOBLES ET FRUITIERS

190	CSE	<b>NEW</b>
191	CSE/C	<b>NEW</b>
192	CSE/FP	<b>NEW</b>
194	CSE UTENSILI	
198	CST BASE	
199	CST PRO	
200	CST/F BASE	
201	CST/F PRO	
202	CST/F MASTER	
203	GPS CONTROL 4.0	
204	CSR	<b>NEW</b>
206	CENTRALINA CNT	
208	CST UTENSILI	
214	CTV BASE	
215	CTV PRO	
216	CTV UTENSILI	
220	IT-M	
222	IT	
224	IT-PRO	
226	ITX	
228	DMI	
230	CST+DMI SINGOLA	
232	CST+DMI DOPPIA	
234	AND-V	
236	AND	
238	DST-STAR	
239	DST-STAR COMPATTA	
240	DST-STAR UTENSILI	
244	DCV	
246	DCV UTENSILI	
248	RCV	<b>NEW</b>
250	ITE	
252	ITF	
254	TDR	
256	TDR UTENSILI	

258	<b>PARTI DI RICAMBIO</b> SPARE PARTS ERSATZTEIL PIEZA DE REPUESTO PIÈCE DE RECHANGE	
-----	---	--

**CONDIZIONI GENERALI DI VENDITA**  
GENERAL TERMS AND CONDITIONS OF SALE  
ALLGEMEINE VERKAUFSBEDINGUNGEN  
CONDICIONES GENERALES DE VENTA  
CONDITIONS GÉNÉRALES DE VENTE



# LEGENDA

ICONS  
IKONEN  
LÉGENDE  
ICÔNES



ORIGINAL MADE IN ITALY

**MOD**

**Modello macchina**  
Machine model  
Maschinenmodell  
Modelo de la máquina  
Modèle de la machine

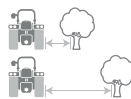

**Distanza min-max trattore/filare**  
Tractor/row min-max distance  
Min-Max-Abstand Traktor/Reihe  
Distancia min-max tractor/hilerá  
Distance min-max tracteur/rangée

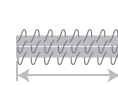

**Larghezza di lavoro rullo**  
Roller working width  
Walzenarbeitsbreite  
Ancho de trabajo del rodillo  
Largeur de travail du rouleau



**Codice macchina**  
Machine code  
Maschinencode  
Código máquina  
Code de la machine



**Ancore**  
Shanks  
Zinken  
Brazos  
Ancres



**Larghezza di lavoro ancore**  
Shanks working width  
Zinkenarbeitsbreite  
Anchura de trabajo de los brazos  
Largeur de travail des ancres

**DX**

**Versione destra**  
Right version  
Rechte Version  
Versión derecha  
Version droit



**Profondità di lavoro ancore**  
Shanks working depth  
Arbeitsiefe Zinken  
Profundidad de trabajo brazos  
Profondeur de travail ancres

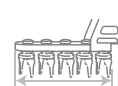

**Larghezza di lavoro interceppo**  
Inter-row working width  
Unterstockgerät-Arbeitsbreite  
Anchura de trabajo intercepas  
Largeur de travail interceps

**SX**

**Versione sinistra**  
Left version  
Linke Version  
Versión izquierda  
Version gauche



**Profondità di lavoro**  
Working depth  
Arbeitsiefe  
Profundidad de trabajo  
Profondeur de travail



**Diametro rullo**  
Diameter roller  
Durchmesser Walze  
Diámetro rodillo  
Diamètre rouleau



**Potenza richiesta alla trattrice**  
Power required from the tractor  
Benötigte Leistung vom Traktor  
Potencia requerida del tractor  
Puissance requise du tracteur



**Coltelli**  
Blades  
Messer  
Cuchillos  
Couteaux

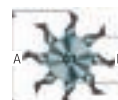

**Dimensioni rotore trincia**  
Dimensions rotor mulcher  
Abmessungen Rotormulcher  
Dimensiones de rotor de la trituradora  
Dimensions du rotor broyeur

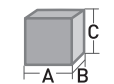

**Dimensioni macchina**  
Machine dimensions  
Abmessungen der Maschine  
Dimensiones de la máquina  
Dimensions de la machine



**Coltelli**  
Blades  
Messer  
Cuchillos  
Couteaux



**Gruppo spostamento idraulico**  
Hydraulic side shift  
Hydraulische Verschiebung  
Kit desplazador hidráulico  
Groupe de déplacement latéral

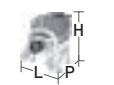

**Dimensioni trincia**  
Mulcher dimensions  
Abmessungen Mulcher  
Dimensiones de la trituradora  
Dimensions du broyeur



**Filo per testata**  
trimmer line  
Schnur  
Hilo  
fil de coupe



**Coltelli per trincia**  
Blades for mulcher  
Messer für Mulchgeräte  
Cuchillos para trituradoras  
Couteaux pour broyeurs



**Dimensioni trincia**  
Mulcher dimensions  
Abmessungen Mulcher  
Dimensiones de la trituradora  
Dimensions du broyeur



**Ø testata interfilare**  
Ø inter-row disc  
Ø schwenscheibe  
Ø cabezal interfilár  
Ø tête inter-rangs



**Mazza per trincia**  
Hammer for mulcher  
Hammer für Mulchgeräte  
Martillo para trituradora  
Marteau pour broyeur



**Peso macchina**  
Machine weight  
Gewicht der Maschine  
Peso de la máquina  
Poids de la machine



**Categoria attacco a tre punti**  
Three-point attack category  
Drei-Punkte-Angriffskategorie  
Categoria de ataque de tres puntos  
Catégorie attaque à trois points



**Aste di raccolta sarmanti**  
Twig rakes  
Holzaufnahmezinken  
Astas de cosecha  
Tiges de ramassage



**Direzione di lavoro macchina**  
Working direction machine  
Maschinenarbeitsrichtung  
Dirección trabajo máquina  
Sens de travail de la machine

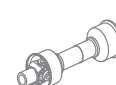

**Cardano**  
PTO drive shaft  
Gelenkwelle  
Transmisión cardanica  
Cardan



**Ø vite per utensile**  
Ø screw for tool  
Ø Schraube für Werkzeug  
Ø tornillo para herramienta  
Ø vis pour outil



**Giri al minuto PTO**  
Revolutions per minute PTO  
Umdrehungen pro Minute PTO Zapfwelle  
Revoluciones por minuto TDF  
Révolutions par minute PDF



**Numero/modello cinghie**  
Number-model of belts  
Anzahl-Modell der Riemen  
Cantidad-modelo de correas  
Nombre-modelle de courroies



**Peso utensile**  
Tool weight  
Werkzeuggewicht  
Peso de la herramienta  
Poids de l'outil



**Attacco a cardano**  
Pto shaft connection  
Anschluss Gelenkwelle  
Acoplamiento a cardán  
Entrainement par cardan



**Lunghezza lama di taglio**  
Cutting blade length  
Schneidmesserlänge  
Longitud de la cuchilla de corte  
Longueur de la lame de coupe



**Numero distributori idraulici**  
Number of hydraulic distributors  
Anzahl der Hydraulikverteiler  
Número de distribuidores hidráulicos  
Nombre de distributeurs hydrauliques



**Attacco alle prese idrauliche**  
Hydraulic tractor connection  
Hydraulischer Traktoranschluss  
Tomas hidráulicas del tractor  
Entrainement hydraulique



**Larghezza utensile**  
Tool width  
Werkzeugbreite  
Ancho de herramienta  
Largeur d'outil



**Potenza massima**  
Maximum power  
Maximale Leistung  
Potencia máxima  
Puissance maximum



**Quantità di olio necessaria**  
Quantities of oil required  
Benötigte Ölmengen  
Cantidad de aceite requerida  
Quantité d'huile nécessaire



**Distanza asse trattore/filare**  
Tractor axle/row distance  
Abstand zwischen Traktorchse/Reihe  
Distancia entre el eje del tractor/hilerá  
Distance entre l'axe du tracteur/rangée

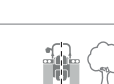

**Distanza asse trattore/filare**  
Tractor axle/row distance  
Abstand zwischen Traktorchse/Reihe  
Distancia entre el eje del tractor/hilerá  
Distance entre l'axe du tracteur/rangée



**Larghezza di lavoro**  
Working width  
Arbeitsbreite  
Ancho de trabajo  
Largeur de travail

## CSE POSTERIORE

CSE REAR  
CSE HINTERE  
CSE TRASERA  
CSE ARRIÈRE

UTENSILI vedere a pag. 194

TOOLS see page 194

WERKZEUGE siehe Seite 194





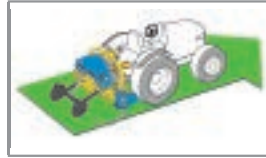



HERRAMIENTAS ver página 194

OUTILS voir page 194



Versione *Light*

L'immagine della macchina è indicativa. Gli utensili e gli accessori sono a richiesta. – The picture of the machine is indicative. Tools and accessories are on request.

MOD								
mod.	cod.	HP	Q l/min	nr	bar	cm	kg	euro
<b>CSE singolo</b>	1003869	30 - 100	20	2 (4 Innesti rapidi)	150	145×118×100	240	<b>4.900,00</b>
<b>CSE doppio</b>	1003870	30 - 100	30	3 (6 Innesti rapidi)	150	180×118×100	320	<b>7.040,00</b>

Di serie	Standard equipment	Serienmässig	Estándar	De série
<ul style="list-style-type: none"> <li>Attacco a 3 punti Cat. I-II</li> <li>Spostamento laterale idraulico apertura/chiusura e regolazione dell'utensile</li> <li>Ruote di appoggio con cresta regolabili in altezza</li> <li>Doppio tastatore</li> <li>Protezioni antinfortunistiche conformi alla normativa CE</li> </ul>	<ul style="list-style-type: none"> <li>3-point linkage cat. I-II</li> <li>Hydraulic side shift opening/closing and tool adjustment</li> <li>Height-adjustable crest wheels</li> <li>Dual sensor</li> <li>Protective equipment as per EC safety rules</li> </ul>	<ul style="list-style-type: none"> <li>3-Punkt-Anbau Kat. I-II</li> <li>Hydraulische Seitenverschiebung öffnen/schließen und Werkzeugverstellung</li> <li>Höhenverstellbare Räder mit Führung</li> <li>Doppelter Taster</li> <li>Unfallschutz nach EU-Vorschriften</li> </ul>	<ul style="list-style-type: none"> <li>Enganche a 3 punto Cat. I-II</li> <li>Desplazamiento lateral hidráulico apertura/cierre y regulación del implemento</li> <li>Rueda de apoyo con regulación en altura</li> <li>Palpador doble</li> <li>Protecciones de seguridad de acuerdo con la norma CE</li> </ul>	<ul style="list-style-type: none"> <li>Attelage 3 points Cat. I-II</li> <li>Déplacement latéral hydraulique pour ouverture/fermeture et réglage de l'outil</li> <li>Roues de support avec guide réglables en hauteur</li> <li>Double palpeur</li> <li>Protections contre les accidents aux normes CE</li> </ul>

cod.	A richiesta	On request	Auf Anfrage	Opcionales	Sur demande	€
5411041	Ruota in ferro senza cresta	Smooth iron wheel	Glatte Eisenräder	Rueda en hierro lisa	Roue en fer lisse	<b>90,00</b>
2050703	kit attacco frontale (solo per versione singola)	Frontal connection kit (only for single version)	Frontanschluss-Kit (nür für Single-Version)	Kit de acople frontal (solo para version individual)	Kit de connexion frontale (uniquement pour la ver. simple)	<b>750,00</b>
2051329 CSE singolo	Kit regolazione idraulica inclinazione utensile Richiede 1 distributore aggiunto (2 innesti rapidi)	Tool inclination hydraulic adjustment kit Requires 1 additional distributor (2 quick couplings)	Hydraulischer Einstellsatz für Werkzeugneigung Erfordert 1 zusätzlichen Verteiler (2 Schnellkupplungen)	Kit de ajuste de inclinación hidráulica de la herramienta, requiere de 1 distribuidor adicional (con sus 2 acoples rápidos).	Kit de réglage hydraulique de l'inclinaison de l'outil Nécessite 1 distributeur supplémentaire (2 raccords rapides)	<b>340,00</b>
2051349 CSE doppio	Kit regolazione idraulica inclinazione utensile Richiede 2 distributori aggiunti (4 innesti rapidi)	Tool inclination hydraulic adjustment kit Requires 2 additional distributors (4 quick couplings)	Hydraulischer Einstellsatz für Werkzeugneigung Erfordert 2 zusätzlichen Verteiler (4 Schnellkupplungen)	Kit de ajuste de inclinación hidráulica de la herramienta, requiere de 2 distribuidores adicional (con sus 4 acoples rápidos).	Kit de réglage hydraulique de l'inclinaison de l'outil Nécessite 2 distributeurs supplémentaires (4 raccords rapides)	<b>680,00</b>

CSE - CSE/C	REAR INTER-ROW TOOL CARRIER
CSE - CSE/C	HINTERER - GERÄTETRÄGER
CSE - CSE/C	BASTIDOR PORTAHERRAMIENTAS INTERFILARES TRASERO
CSE - CSE/C	CHÂSSIS PORTE-OUTILS ARRIÈRE



ORIGINAL MADE IN ITALY

## CSE/C POSTERIORE

CSE/C REAR  
CSE/C HINTERE  
CSE/C TRASERA  
CSE/C ARRIÈRE

UTENSILI vedere a pag. 194

TOOLS see page 194

WERKZEUGE siehe Seite 194

HERRAMIENTAS ver página 194

OUTILS voir page 194

## VERSIONE COMPATTA NARROW VERSION

**NEW**

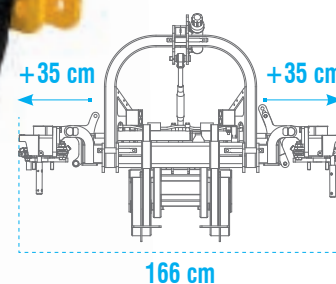
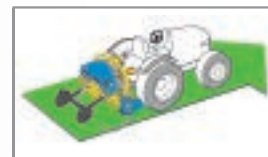

Versione *Light*

L'immagine della macchina è indicativa. Gli utensili e gli accessori sono a richiesta. – The picture of the machine is indicative. Tools and accessories are on request.

MOD								
mod.	cod.	HP	Q l/min	nr	bar	cm	kg	euro
<b>CSE/C singolo</b>	1003871	30 - 100	20	2 (4 Innesti rapidi)	150	125×118×100	200	<b>4.580,00</b>
<b>CSE/C doppio</b>	1003872	30 - 100	30	3 (6 Innesti rapidi)	150	165×118×100	280	<b>6.640,00</b>

Di serie	Standard equipment	Serienmässig	Estándar	De série
<ul style="list-style-type: none"> <li>Attacco a 3 punti Cat. I</li> <li>Spostamento laterale idraulico apertura/chiusura e regolazione dell'utensile</li> <li>Ruote di appoggio con cresta regolabili in altezza</li> <li>Doppio tastatore</li> <li>Protezioni antinfortunistiche conformi alla normativa CE</li> </ul>	<ul style="list-style-type: none"> <li>3-point linkage cat. I</li> <li>Hydraulic side shift opening/closing and tool adjustment</li> <li>Support wheels with height adjustable ridge</li> <li>Dual sensor</li> <li>Protective equipment as per EC safety rules</li> </ul>	<ul style="list-style-type: none"> <li>3-Punkt-Anbau Kat. I</li> <li>Hydraulische Seitenverschiebung öffnen/schließen und Werkzeugverstellung</li> <li>Höhenverstellbare Räder mit Führung</li> <li>Doppelter Taster</li> <li>Unfallschutz nach EU-Vorschriften</li> </ul>	<ul style="list-style-type: none"> <li>Enganche a 3 punto Cat. I</li> <li>Desplazamiento lateral hidráulico apertura/cierre y regulación del implemento</li> <li>Rueda de apoyo con regulación en altura</li> <li>Palpador doble</li> <li>Protecciones de seguridad de acuerdo con la norma CE</li> </ul>	<ul style="list-style-type: none"> <li>Attelage 3 points Cat. I</li> <li>Déplacement latéral hydraulique pour ouverture/fermeture et réglage de l'outil</li> <li>Roues de support avec guide réglables en hauteur</li> <li>Double palpeur</li> <li>Protections contre les accidents aux normes CE</li> </ul>

cod.	A richiesta	On request	Auf Anfrage	Opcionales	Sur demande	€
5411041	Ruota in ferro senza cresta	Smooth iron wheel	Glatte Eisenräder	Rueda en hierro lisa	Roue en fer lisse	<b>90,00</b>
2050703	kit attacco frontale (solo per versione singola)	Frontal connection kit (only for single version)	Frontanschluss-Kit (nur für Single-Version)	Kit de acople frontal (solo para version individual)	Kit de connexion frontale (uniquement pour la ver. simple)	<b>750,00</b>
2051330 CSE/C singolo	Kit regolazione idraulica inclinazione utensile Richiede 1 distributore aggiunto (2 innesti rapidi)	Tool inclination hydraulic adjustment kit Requires 1 additional distributor (2 quick couplings)	Hydraulischer Einstellsatz für Werkzeugneigung Erfordert 1 zusätzlichen Verteiler (2 Schnellkupplungen)	Kit de ajuste de inclinación hidráulica de la herramienta, requiere de 1 distribuidor adicional (con sus 2 acoples rápidos).	Kit de réglage hydraulique de l'inclinaison de l'outil Nécessite 1 distributeur supplémentaire (2 raccords rapides)	<b>340,00</b>
2051350 CSE/C doppio	Kit regolazione idraulica inclinazione utensile Richiede 2 distributori aggiunti (4 innesti rapidi)	Tool inclination hydraulic adjustment kit Requires 2 additional distributors (4 quick couplings)	Hydraulischer Einstellsatz für Werkzeugneigung Erfordert 2 zusätzlichen Verteiler (4 Schnellkupplungen)	Kit de ajuste de inclinación hidráulica de la herramienta, requiere de 2 distribuidores adicional (con sus 4 acoples rápidos).	Kit de réglage hydraulique de l'inclinaison de l'outil Nécessite 2 distributeurs supplémentaires (4 raccords rapides)	<b>680,00</b>

CSE/C

## CSE/FP ANTERIORE

CSE/FP FRONT

CSE/FP VORDERE

CSE/FP DELANTERA

CSE/FP AVANT

**UTENSILI vedere a pag. 194**

TOOLS see page 194

WERKZEUGE siehe Seite 194

HERRAMIENTAS ver página 194









OUTILS voir page 194



**NEW**

Versione *Light*

L'immagine della macchina è indicativa. Gli utensili e gli accessori sono a richiesta. – The picture of the machine is indicative. Tools and accessories are on request.

MOD								
mod.	cod.	HP	Q l/min	nr	bar	cm	kg	euro
<b>CSE/FP singolo</b>	1003873	30 - 100	30	3 (6 Innesti rapidi)	150	145×138×116	330	<b>7.060,00</b>
<b>CSE/FP doppio</b>	1003874	30 - 100	40	4 (8 Innesti rapidi)	150	180×138×116	410	<b>9.260,00</b>

Di serie	Standard equipment	Serienmässig	Estándar	De série
<ul style="list-style-type: none"> <li>Attacco da flangiare al sollevamento frontale del trattore</li> <li>Spostamento laterale idraulico apertura/chiusura e regolazione dell'utensile</li> <li>Regolazione idraulica castello frontale</li> <li>Ruote di appoggio senza cresta regolabili in altezza</li> <li>Doppio tastatore</li> <li>Protezioni antinfortunistiche conformi alla normativa CE</li> </ul>	<ul style="list-style-type: none"> <li>Attachment to be flanged to the front lifting of the tractor</li> <li>Hydraulic opening/closing lateral movement and tool adjustment</li> <li>Front castle hydraulic adjustment</li> <li>Support wheels without crest adjustable in height</li> <li>Dual sensor</li> <li>Protective equipment as per EC safety rules</li> </ul>	<ul style="list-style-type: none"> <li>Anbaugerät zum Anflanschen an die Frontaushebung des Schleppers</li> <li>Hydraulische Öffnungs-/Schließseitenbewegung und Werkzeugeinstellung</li> <li>Hydraulische Verstellung des vorderen Schlosses</li> <li>Stützräder ohne Kamm höhenverstellbar</li> <li>Doppelter Taster</li> <li>Unfallschutz nach EU-Vorschriften</li> </ul>	<ul style="list-style-type: none"> <li>Accesorio para ser embreado a la elevación delantera del tractor</li> <li>Movimiento lateral de apertura/cierre hidráulico y ajuste de herramienta</li> <li>Regulación hidráulica castillo delantero</li> <li>Ruedas de apoyo sin cresta regulables en altura</li> <li>Palpador doble</li> <li>Protecciones de seguridad de acuerdo con la norma CE</li> </ul>	<ul style="list-style-type: none"> <li>Attelage à brider au relevage avant du tracteur</li> <li>Mouvement latéral d'ouverture/fermeture hydraulique et réglage de l'outil</li> <li>Réglage hydraulique du château avant</li> <li>Roues de support sans crête réglables en hauteur</li> <li>Double palpeur</li> <li>Protections contre les accidents aux normes CE</li> </ul>

cod.	A richiesta	On request	Auf Anfrage	Opcionales	Sur demande	€
5411040	Ruote con cresta	Crest wheel	Räder mit Führung	Ruedas de apoyo con guía	Roues de support avec guide	<b>121,60</b>
2051331 CSE/FP singolo	Kit regolazione idraulica inclinazione utensile Richiede 1 distributore aggiunto (2 innesti rapidi)	Tool inclination hydraulic adjustment kit Requires 1 additional distributor (2 quick couplings)	Hydraulischer Einstellsatz für Werkzeugneigung Erfordert 1 zusätzlichen Verteiler (2 Schnellkupplungen)	Kit de ajuste de inclinación hidráulica de la herramienta, requiere de 1 distribuidor adicional (con sus 2 acoples rápidos).	Kit de réglage hydraulique de l'inclinaison de l'outil Nécessite 1 distributeur supplémentaire (2 raccords rapides)	<b>340,00</b>
2051351 CSE/FP doppio	Kit regolazione idraulica inclinazione utensile Richiede 2 distributori aggiunti (4 innesti rapidi)	Tool inclination hydraulic adjustment kit Requires 2 additional distributors (4 quick couplings)	Hydraulischer Einstellsatz für Werkzeugneigung Erfordert 2 zusätzlichen Verteiler (4 Schnellkupplungen)	Kit de ajuste de inclinación hidráulica de la herramienta, requiere de 2 distribuidores adicional (con sus 4 acoples rápidos).	Kit de réglage hydraulique de l'inclinaison de l'outil Nécessite 2 distributeurs supplémentaires (4 raccords rapides)	<b>680,00</b>



1964  
2024  
**60**  
ANNIVERSARY

**CSE**

Versione *Light*

## UTENSILI

WORKING TOOLS

WERKZEUGE

HERRAMIENTAS DE TRABAJO

OUTILS DE TRAVAIL

CSE





CSE-C

CSE-FP

**Kit ancora aprisolco**  
**Kit anchor fixed**  
**Kit Zinken Fest**  
**Kit punta abre surco**  
**Kit ancre**

			
	cod.	kg	euro
	2050687	8	140,00

**Kit disco aprisolco**  
**Kit disc fixed**  
**Kit Scheibenpflug fest**  
**Disco de corte**  
**Kit disque**

			
	cod.	kg	euro
	2050690 DX	8	460,00
2050691 SX	8	460,00	

**Kit ruota di profondità**  
**Kit depth wheel**  
**Kit Tiefenrad**  
**Kit rueda de profundidad**  
**Kit roue de profondeur**

			
	cod.	kg	euro
	2051277	9	295,00

### LSI







**Kit lama scalzatrice**  
 con ala laterale ed esploratori

**Kit blade weeder** and side  
 deflectors for weeder blade

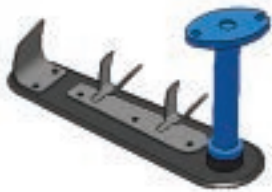
**Kit Stockräumer** und Deflektoren  
 für Abraumschar

**Kit cuchilla interfilar** y aletas  
 para cuchilla binadora

**Kit lame** et sous-soleuses pour  
 lame sarclouse

						
	cod.	cm	cm	cm	kg	euro
	2050681 DX	L = 55	125	125   125	10	420,00
	2050682 SX		185	185   185		420,00
	2051364 DX	L = 70	140	140   140	11	440,00
2051365 SX	200		200   200	440,00		







**Kit lama paraterra**  
 per CSE posteriore  
 solo per:  
 Kit aratro scalzatore

**Kit soil & stone deflector**  
 for rear CSE  
 only for:  
 Kit plough

**Kit Erd- & Steinschieber**  
 für hinteres CSE  
 nur für:  
 Kit Pflug

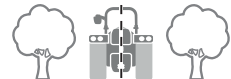
**Kit cuchilla para-tierra**  
 para CSE trasero  
 solo para:  
 Kit arado desaporcador

**Kit lame convoyeur de terre**  
 pour CSE arrière  
 uniquement pour:  
 Kit charrue

						
	cod.	cm	cm	l/min	kg	euro
	2050685 DX	90	90   90	--	25	920,00
2050686 SX	150	150   150	--	25	920,00	

Solo per versione CSE e CSE/C - Only for CSE and CSE/C version - Nur für CSE und CSE/C Version - Sólo para las versiones CSE y CSE/C - Uniquement pour les versions CSE et CSE/C







**Kit lama paraterra**  
 per CSE anteriore  
 solo per:  
 Kit aratro scalzatore

**Kit soil & stone deflector**  
 for front CSE  
 only for:  
 Kit plough

**Kit Erd- & Steinschieber**  
 für vordere CSE  
 nur für:  
 Kit Pflug

**Kit cuchilla para-tierra**  
 para CSE frontal  
 solo para:  
 Kit arado desaporcador

**Kit lame convoyeur de terre**  
 pour CSE avant  
 uniquement pour:  
 Kit charrue

						
	cod.	cm	cm	l/min	kg	euro
	2050804 DX	90	90   90	--	25	920,00
2050805 SX	150	150   150	--	25	920,00	

Solo per versione CSE/FP - Only for CSE/FP version - Nur für CSE/FP Version - Sólo para la versión CSE/FP - Uniquement pour la version CSE/FP



CSE	REAR INTER-ROW TOOL CARRIER
CSE	GERÄTETRÄGER HINTERER
CSE	BASTIDOR PORTAHERRAMIENTAS TRASERO
CSE	CHÂSSIS PORTE-OUTILS ARRIERE



ORIGINAL MADE IN ITALY

## ASI

Kit aratro scalzatore con spatola pulisci ceppo. Profondità di lavoro max 15 cm	Kit plough with row cleaner blade. Working depth max. 15 cm	Kit Pflug mit Säuberungschar. Max. Arbeitstiefe 15 cm	Kit arado desporcador con espátula limpia cepas. Profundidad de trabajo máx. 15 cm	Kit charrue avec spatule de nettoyage des cepes. Profondeur de travail max 15 cm
	<b>cod.</b>	<b>cm</b>	<b>cm</b>	<b>l/min</b>
	2050683 DX	128	128 : 128	--
	2050684 SX	188	188 : 188	--
				<b>kg</b>
				18
				<b>euro</b>
				990,00
				18
				990,00

## DRT

Kit dischi rinalzatori trainati, 2 dischi in parallelo Profondità di lavoro 7 cm	Kit trailed ridging discs 2 discs in line Working depth 7 cm	Kit Gezogenes Scheiben zum Häufeln, 2 Scheiben parallel Arbeitstiefe 7 cm	Kit discos para recalzar arrastrado 2 discos en paralelo Profundidad de trabajo 7 cm	Kit disques émotteurs trainés 2 disques en parallèle Profondeur de travail 7 cm
	<b>cod.</b>	<b>cm</b>	<b>cm</b>	<b>l/min</b>
	2051182 DX	120	120 : 120	30
	2051183 SX	180	180 : 180	30
				<b>kg</b>
				25
				<b>euro</b>
				1.350,00
				25
				1.350,00

## SPR

Kit spollonatrice Larghezza di lavoro 56 cm	Kit shoot remover Working width 56 cm	Kit Stockputzer Arbeitsbreite 56 cm	Kit removedor de brotes Ancho de trabajo 56 cm	Kit brosse rotative Largeur de travail 56 cm
	<b>cod.</b>	<b>cm</b>	<b>cm</b>	<b>l/min</b>
	2050845 DX	165	165 : 165	30
	2050846 SX	225	225 : 225	30
				<b>kg</b>
				40
				<b>euro</b>
				2.290,00
				40
				2.290,00

## IT - Ø50 LAME

Kit testata IT lame 2 lame Ø di lavoro 50 cm	Kit disc-mower IT blades 2 blades Working Ø 50 cm	Scheibenmäher IT Messerklingen 2 Messerklingen Arbeits-Ø 50 cm	Kit cabezal interfila IT cuchilla 2 cuchilla Ø de trabajo 50 cm	Kit disque satellite IT lames 2 lames Ø de travail 50 cm
	<b>cod.</b>	<b>cm</b>	<b>cm</b>	<b>l/min</b>
	2050823 DX	140	140 : 140	30
	2050824 SX	200	200 : 200	30
				<b>kg</b>
				35
				<b>euro</b>
				2.490,00
				35
				2.490,00

## ITF - Ø50 FILO

Kit testata IT filo 4 Fili (8 taglianti) Ø 6 Ø di lavoro 50 cm	Kit disc-mower IT wire 4 wires (8 cutting edges) Ø 6 Working Ø 50 cm	Kit Scheibenmäher IT Faden 4 Drähte (8 Schneidkanten) Ø 6 Arbeits-Ø 50 cm	Kit cabezal interfila IT hilo 4 hilos (8 fillos de corte) Ø 6 Ø de trabajo 50 cm	Kit disque satellite IT fil 4 fils (8 tranchants) Ø 6 Ø de travail 50 cm
	<b>cod.</b>	<b>cm</b>	<b>cm</b>	<b>l/min</b>
	2050827 DX	140	140 : 140	30
	2050828 SX	200	200 : 200	30
				<b>kg</b>
				32
				<b>euro</b>
				2.140,00
				32
				2.140,00

## UTENSILI

WORKING TOOLS

WERKZEUGE







HERRAMIENTAS DE TRABAJO







OUTILS DE TRAVAIL

CSE







CSE-C

CSE-FP







Kit disco anteriore rollhacke	Kit rollhacke front disc	Kit Rollhacke front	Kit disco anterior rollhacke	Kit disque anterieur rollhacke		
						
	cod.	cm	cm	l/min	kg	euro
	2050919 DX	92	92   92	--	14	950,00
	2050920 SX	152	152   152	--	14	950,00

Kit disco anteriore rollhacke doppio "BOOMERANG"	Kit double rollhacke front discs "BOOMERANG"	Kit Doppel-Rollhacke front "BOOMERANG"	Kit disco anterior rollhacke doble "BOOMERANG"	Kit disque anterieur rollhacke double "BOOMERANG"		
						
	cod.	cm	cm	l/min	kg	euro
	2050921 DX	102	102   102	--	28	1.150,00
	2050922 SX	162	162   162	--	28	1.150,00

### Ø 540

Disco sarchiatore a dita Disco stella Ø 540 Densità dura - Colore rosso	Finger weeder Star disc Ø 540 Hard density - Red color	Fingerhacke Sternscheibe Ø 540 Harte Dichte - Rote Farbe	Disco cultivador a dedos Disco estrella Ø 540 Densidad dura - Color rojo	Disque sarclage à doigts Disque étoile Ø 540 Densité dure - Couleur rouge		
						
	cod.	cm	cm	l/min	kg	euro
	2050913 DX	108	108   108	--	36	1.750,00
	2060583 SX	182	182   182	--	36	1.750,00

### Ø 700

Disco sarchiatore a dita Disco stella Ø 700 Densità dura - Colore rosso	Finger weeder Star disc Ø 700 Hard density - Red color	Fingerhacke Sternscheibe Ø 700 Harte Dichte - Rote Farbe	Disco cultivador a dedos Disco estrella Ø 700 Densidad dura - Color rojo	Disque sarclage à doigts Disque étoile Ø 700 Densité dure - Couleur rouge		
						
	cod.	cm	cm	l/min	kg	euro
	2050916 DX	120	120   120	--	50	2.370,00
	2060586 SX	192	192   192	--	50	2.370,00

<b>CSE</b>	REAR INTER-ROW TOOL CARRIER
<b>CSE</b>	GERÄTETRÄGER HINTERER
<b>CSE</b>	BASTIDOR PORTAHERRAMIENTAS TRASERO
<b>CSE</b>	CHÂSSIS PORTE-OUTILS ARRIERE



ORIGINAL MADE IN ITALY

# UTENSILI

## WORKING TOOLS

## WERKZEUGE

## HERRAMIENTAS DE TRABAJO

## OUTILS DE TRAVAIL



CSE UTENSILI

Ø 540

Disco sarchiatore a dita Disco stella Ø 540 Densità media - Colore giallo	Finger weeder Star disc Ø 540 Medium density - Yellow color	Fingerhacke Sternscheibe Ø 540 Mittlere Dichte - Gelbe Farbe	Disco cultivador a dedos Disco estrella Ø 540 Densidad media - Color amarillo	Disque sarclage à doigts Disque étoile Ø 540 Densité moyenne - Couleur jaune	
cod.	cm	cm	l/min	kg	euro
2050915 DX	108	108   108	--	36	1.750,00
2060585 SX	182	182   182	--	36	1.750,00

Ø 700

Disco sarchiatore a dita Disco stella Ø 700 Densità media - Colore giallo	Finger weeder Star disc Ø 700 Medium density - Yellow color	Fingerhacke Sternscheibe Ø 700 Mittlere Dichte - Gelbe Farbe	Disco cultivador a dedos Disco estrella Ø 700 Densidad media - Color amarillo	Disque sarclage à doigts Disque étoile Ø 700 Densité moyenne - Couleur jaune	
cod.	cm	cm	l/min	kg	euro
2050918 DX	120	120   120	--	50	2.370,00
2060588 SX	192	192   192	--	50	2.370,00

Ø 540

Disco sarchiatore a dita Disco stella Ø 540 Densità morbida - Colore arancione	Finger weeder Star disc Ø 540 Soft density - Orange color	Fingerhacke Sternscheibe Ø 540 Weiche Dichte - Orange Farbe	Disco cultivador a dedos Disco estrella Ø 540 Densidad suave - Color naranja	Disque sarclage à doigts Disque étoile Ø 540 Densité douce - Couleur orange	
cod.	cm	cm	l/min	kg	euro
2050914 DX	108	108   108	--	36	1.750,00
2060584 SX	182	182   182	--	36	1.750,00

Ø 700

Disco sarchiatore a dita Disco stella Ø 700 Densità morbida - Colore arancione	Finger weeder Star disc Ø 700 Soft density - Orange color	Fingerhacke Sternscheibe Ø 700 Weiche Dichte - Orange Farbe	Disco cultivador a dedos Disco estrella Ø 700 Densidad suave - Color naranja	Disque sarclage à doigts Disque étoile Ø 700 Densité douce - Couleur orange	
cod.	cm	cm	l/min	kg	euro
2050917 DX	120	120   120	--	50	2.370,00
2060587 SX	192	192   192	--	50	2.370,00

## BASE POSTERIORE

REAR BASE  
HINTERE BASISVERSION  
BASE TRASERA  
BASE ARRIÈRE

UTENSILI vedere a pag. 208



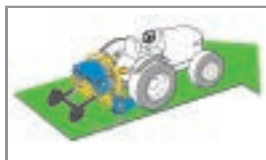

TOOLS see page 208  
WERKZEUGE siehe Seite 208  
HERRAMIENTAS ver página 208  
OUTILS voir page 208

CST BASE



## CST BASE

L'immagine della macchina è indicativa. Gli utensili e gli accessori sono a richiesta. – The picture of the machine is indicative. Tools and accessories are on request.

MOD					
mod.	cod.	HP	cm	kg	euro
<b>CST BASE singolo</b>	1003028	30 - 100	145×118×100	350	<b>8.350,00</b>
<b>CST BASE doppio</b>	1003029	30 - 100	180×118×100	400	<b>12.050,00</b>

### Di serie

- Attacco a 3 punti Cat. I-II
- Sistema filtrante
- Joystick multifunzione
- Spostamento laterale idraulico apertura/chiusura e regolazione dell'utensile
- Regolazione idraulica inclinazione dell'utensile
- Comando di emergenza
- Ruote di appoggio con cresta regolabili in altezza
- Doppio tastatore
- Protezioni antinfortunistiche conformi alla normativa CE

### Standard equipment

- 3-point linkage cat. I-II
- Filtering system
- Multifunction Joystick
- Hydraulic side shift opening/closing and tool adjustment
- Hydraulic tilt tool adjustment
- Emergency control
- Height-adjustable crest wheels
- Dual sensor
- Protective equipment as per EC safety rules

### Serienmässig

- 3-Punkt-Anbau Kat. I-II
- Filtersystem
- Multifunktions-Joystick
- Hydraulische Seitenverschiebung öffnen/schließen und Werkzeugverstellung
- Hydraulische Werkzeugneigungsverstellung
- Notfallsteuerung
- Höhenverstellbare Räder mit Führung
- Doppelter Taster
- Unfallschutz nach EU-Vorschriften

### Estándar

- Enganche a 3 punto Cat. I-II
- Sistema filtrante
- Joystick multifunción
- Desplazamiento lateral hidráulico apertura/cierre y regulación del implemento
- Regulación hidráulica inclinación del implemento
- Comando de emergencia
- Rueda de apoyo con regulación en altura
- Palpador doble
- Protecciones de seguridad de acuerdo con la norma CE

### De série

- Attelage 3 points Cat. I-II
- Système de filtration
- Joystick multifonction
- Déplacement latéral hydraulique pour ouverture/fermeture et réglage de l'outil
- Réglage hydraulique inclinaison de l'outil
- Commande d'urgence
- Roues de support avec guide réglables en hauteur
- Double palpeur
- Protections contre les accidents aux normes CE

cod.	A richiesta	On request	Auf Anfrage	Opcionales	Sur demande	€
5411041	Ruota in ferro senza cresta	Smooth iron wheel	Glatte Eisenräder	Rueda de hierro lisa	Roue en fer lisse	<b>90,00</b>

CST	TOOL CARRIER
CST	GERÄTETRÄGER
CST	BASTIDOR PORTAHERRAMIENTAS
CST	CHÂSSIS PORTE-OUTILS



ORIGINAL MADE IN ITALY

## PRO POSTERIORE

- REAR PRO
- HINTERE PROFIVERSION
- PRO TRASERA
- PRO ARRIÈRE

### UTENSILI vedere a pag. 208

- TOOLS see page 208
- WERKZEUGE siehe Seite 208
- HERRAMIENTAS ver página 208
- OUTILS voir page 208



JOYSTICK MULTIFUNZIONE

CST PRO



## CST PRO

L'immagine della macchina è indicativa. Gli utensili e gli accessori sono a richiesta. – The picture of the machine is indicative. Tools and accessories are on request.

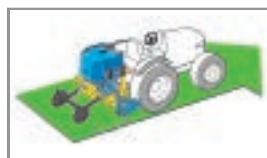

MOD	Barcode	Tractor	Attachment	Dimensions (LxPxH)	Weight (W)	Price (€)
mod.	cod.	HP	type	cm	kg	euro
<b>CST PRO singolo</b>	1003047	30 - 100	T-50	145×118×110	390	<b>10.920,00</b>
<b>CST PRO doppio</b>	1003048	30 - 100	T-60	180×118×110	450	<b>16.650,00</b>

Di serie	Standard equipment	Serienmässig	Estándar	De série
<ul style="list-style-type: none"> <li>Attacco a 3 punti Cat. I-II</li> <li>Impianto oleodinamico completo di serbatoio, sistema filtrante e scambiatore di calore</li> <li>Joystick multifunzione</li> <li>Spostamento laterale idraulico apertura/chiusura e regolazione dell'utensile</li> <li>Regolazione idraulica inclinazione dell'utensile</li> <li>Comando di emergenza</li> <li>Ruote di appoggio con cresta regolabili in altezza</li> <li>Doppio tastatore</li> <li>Kit lama scalzatrice</li> <li>Protezioni antinfortunistiche conformi alla normativa CE</li> </ul>	<ul style="list-style-type: none"> <li>3-point linkage cat. I-II</li> <li>Hydraulic system complete with tank, filter system and heat exchanger</li> <li>Multifunction Joystick</li> <li>Hydraulic side shift opening/closing and tool adjustment</li> <li>Hydraulic tilt tool adjustment</li> <li>Emergency control</li> <li>Height-adjustable crest wheels</li> <li>Dual sensor</li> <li>Kit blade weeder and side deflectors for weeder blade</li> <li>Protective equipment as per EC safety rules</li> </ul>	<ul style="list-style-type: none"> <li>3-Punkt-Anbau Kat. I-II</li> <li>Hydraulisches System komplett mit Tank, Filtersystem und Wärmetauscher</li> <li>Multifunktions-Joystick</li> <li>Hydraulische Seitenverschiebung öffnen/schließen und Werkzeugverstellung</li> <li>Hydraulische Werkzeugneigungsverstellung</li> <li>Notfallsteuerung</li> <li>Höhenverstellbare Räder mit Führung</li> <li>Doppelter Taster</li> <li>Kit Stockräumer</li> <li>Unfallschutz nach EU-Vorschriften</li> </ul>	<ul style="list-style-type: none"> <li>Enganche a 3 punto Cat. I-II</li> <li>Kit de centralita hidráulica completa de depósito, sistema filtrante e intercambiador de calor</li> <li>Joystick multifunción</li> <li>Desplazamiento lateral hidráulico apertura/cierre y regulación del implemento</li> <li>Regulación hidráulica inclinación del implemento</li> <li>Comando de emergencia</li> <li>Rueda de apoyo con regulación en altura</li> <li>Palpador doble</li> <li>Kit cuchilla interfilar</li> <li>Protecciones de seguridad de acuerdo con la norma CE</li> </ul>	<ul style="list-style-type: none"> <li>Attelage 3 points Cat. I-II</li> <li>Système hydraulique complet avec réservoir, système de filtrage et échangeur de chaleur</li> <li>Joystick multifonction</li> <li>Déplacement latéral hydraulique pour ouverture/fermeture et réglage de l'outil</li> <li>Réglage hydraulique inclinaison de l'outil</li> <li>Commande d'urgence</li> <li>Roues de support avec guide réglables en hauteur</li> <li>Double palpeur</li> <li>Kit lame et sous-soleuses pour lame sarclouse</li> <li>Protections contre les accidents aux normes CE</li> </ul>

cod.	A richiesta	On request	Auf Anfrage	Opcionales	Sur demande	€
5130005	Cardano T-50	PTO shaft T-50	Gelenkwelle T-50	Cardán T-50	Cardan T-50	<b>273,00</b>
5130009	Cardano T-60	PTO shaft T-60	Gelenkwelle T-60	Cardán T-60	Cardan T-60	<b>300,00</b>
5411041	Ruota in ferro senza cresta	Smooth iron wheel	Glatte Eisenräder	Rueda de hierro lisa	Roue en fer lisse	<b>90,00</b>

## BASE ANTERIORE

FRONT BASE  
VORDERE BASISVERSION  
BASE DELANTERA  
BASE AVANT

**UTENSILI vedere a pag. 208**

TOOLS see page 208

WERKZEUGE siehe Seite 208

HERRAMIENTAS ver página 208





OUTILS voir page 208



## CST/F BASE

L'immagine della macchina è indicativa. Gli utensili e gli accessori sono a richiesta. – The picture of the machine is indicative. Tools and accessories are on request.



MOD					
mod.	cod.	HP	cm	kg	euro
<b>CST/F BASE singolo</b>	1003085	30 - 100	145×130×100	390	<b>8.360,00</b>
<b>CST/F BASE doppio</b>	1003086	30 - 100	180×130×100	480	<b>12.510,00</b>

### Di serie

- Attacco a 3 punti Cat. II
- Joystick multifunzione
- Spostamento laterale idraulico apertura/chiusura e regolazione dell'utensile
- Regolazione idraulica inclinazione dell'utensile
- Comando di emergenza
- Ruote di appoggio regolabili in altezza
- Doppio tastatore
- Protezioni antinfortunistiche conformi alla normativa CE

### Standard equipment

- 3-point linkage cat. II
- Multifunction Joystick
- Hydraulic side shift opening/closing and tool adjustment
- Hydraulic tilt tool adjustment
- Emergency control
- Height-adjustable wheels
- Dual sensor
- Protective equipment as per EC safety rules

### Serienmässig

- 3-Punkt-Anbau Kat. II
- Multifunktions-Joystick
- Hydraulische Seitenverschiebung öffnen/schließen und Werkzeugverstellung
- Hydraulische Werkzeugneigungsverstellung
- Notfallsteuerung
- Höhenverstellbare Räder
- Doppelter Taster
- Unfallschutz nach EU-Vorschriften

### Estándar

- Enganche a 3 punto Cat. II
- Joystick multifunción
- Desplazamiento lateral hidráulico apertura/cierre y regulación del implemento
- Regulación hidráulica inclinación del implemento
- Comando de emergencia
- Rueda de apoyo con regulación en altura
- Palpador doble
- Protecciones de seguridad de acuerdo con la norma CE

### De série

- Attelage 3 points Cat. II
- Joystick multifonction
- Déplacement latéral hydraulique pour ouverture/fermeture et réglage de l'outil
- Réglage hydraulique inclinaison de l'outil
- Commande d'urgence
- Roues de support avec guide réglables en hauteur
- Double palpeur
- Protections contre les accidents aux normes CE

cod.	A richiesta	On request	Auf Anfrage	Opcionales	Sur demande	€
5411041	Ruota in ferro senza cresta	Smooth iron wheel	Glatte Eisenräder	Rueda de hierro lisa	Roue en fer lisse	<b>90,00</b>

CST/F	TOOL CARRIER
CST/F	GERÄTETRÄGER
CST/F	BASTIDOR PORTAHERRAMIENTAS
CST/F	CHÂSSIS PORTE-OUTILS



ORIGINAL MADE IN ITALY

## PRO ANTERIORE

FRONT PRO  
VORDERE PROFIVERSION  
PRO DELANTERA  
PRO AVANT

**UTENSILI vedere a pag. 208**

TOOLS see page 208

WERKZEUGE siehe Seite 208

HERRAMIENTAS ver página 208

OUTILS voir page 208



# CST/F PRO

L'immagine della macchina è indicativa. Gli utensili e gli accessori sono a richiesta. – The picture of the machine is indicative. Tools and accessories are on request.

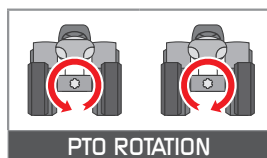

PTO ROTATION

All'ordine specificare sempre:  
To order, always specify:  
Bestellen sie immer:  
Al ordenar, siempre especificar:  
Pour commander spécifiez toujours:

MOD						
mod.	cod.	HP	type	cm	kg	euro
<b>CST/F PRO singolo</b>	1003087	30 - 100	T-50	145×130×110	430	<b>13.000,00</b>
<b>CST/F PRO doppio</b>	1003088	30 - 100	T-60	180×130×110	560	<b>19.500,00</b>

Di serie	Standard equipment	Serienmässig	Estándar	De série
<ul style="list-style-type: none"> <li>• Attacco a 3 punti Cat. II</li> <li>• Impianto oleodinamico completo di serbatoio, sistema filtrante e scambiatore di calore</li> <li>• Joystick multifunzione</li> <li>• Spostamento laterale idraulico apertura/chiusura e regolazione dell'utensile</li> <li>• Regolazione idraulica inclinazione dell'utensile</li> <li>• Comando di emergenza</li> <li>• Ruote di appoggio regolabili in altezza</li> <li>• Doppio tastatore</li> <li>• Kit lama scalzatrice</li> <li>• Protezioni antinfortunistiche conformi alla normativa CE</li> </ul>	<ul style="list-style-type: none"> <li>• 3-point linkage cat. II</li> <li>• Hydraulic system complete with tank, filter system and heat exchanger</li> <li>• Multifunction Joystick</li> <li>• Hydraulic side shift opening/closing and tool adjustment</li> <li>• Hydraulic tilt tool adjustment</li> <li>• Emergency control</li> <li>• Height-adjustable wheels</li> <li>• Dual sensor</li> <li>• Kit blade weeder and side deflectors for weeder blade</li> <li>• Protective equipment as per EC safety rules</li> </ul>	<ul style="list-style-type: none"> <li>• 3-Punkt-Anbau Kat. II</li> <li>• Hydraulisches System komplett mit Tank, Filtersystem und Wärmetauscher</li> <li>• Multifunktions-Joystick</li> <li>• Hydraulische Seitenverschiebung öffnen/schließen und Werkzeugverstellung</li> <li>• Hydraulische Werkzeugneigungsverstellung</li> <li>• Notfallsteuerung</li> <li>• Höhenverstellbare Räder</li> <li>• Doppelter Taster</li> <li>• Kit Stockräumer</li> <li>• Unfallschutz nach EU-Vorschriften</li> </ul>	<ul style="list-style-type: none"> <li>• Enganche a 3 punto Cat. II</li> <li>• Kit de centralita hidráulica completa de depósito, sistema filtrante e intercambiador de calor</li> <li>• Joystick multifunción</li> <li>• Desplazamiento lateral hidráulico apertura/cierre y regulación del implemento</li> <li>• Regulación hidráulica inclinación del implemento</li> <li>• Comando de emergencia</li> <li>• Rueda de apoyo con regulación en altura</li> <li>• Palpador doble</li> <li>• Kit cuchilla interfilar</li> <li>• Protecciones de seguridad de acuerdo con la norma CE</li> </ul>	<ul style="list-style-type: none"> <li>• Attelage 3 points Cat. II</li> <li>• Système hydraulique complet avec réservoir, système de filtrage et échangeur de chaleur</li> <li>• Joystick multifonction</li> <li>• Déplacement latéral hydraulique pour ouverture/fermeture et réglage de l'outil</li> <li>• Réglage hydraulique inclinaison de l'outil</li> <li>• Commande d'urgence</li> <li>• Roues de support réglables en hauteur</li> <li>• Double palpeur</li> <li>• Kit lame et sous-soleuses pour lame sarcluse</li> <li>• Protections contre les accidents aux normes CE</li> </ul>

cod.	A richiesta	On request	Auf Anfrage	Opcionales	Sur demande	€
5130005	Cardano T-50	PTO shaft T-50	Gelenkwelle T-50	Cardán T-50	Cardan T-50	<b>273,00</b>
5130009	Cardano T-60	PTO shaft T-60	Gelenkwelle T-60	Cardán T-60	Cardan T-60	<b>300,00</b>
5411041	Ruota in ferro senza cresta	Smooth iron wheel	Glatte Eisenräder	Rueda de hierro lisa	Roue en fer lisse	<b>90,00</b>

CST/F PRO

### CST/F MASTER con centralina posteriore

CST/F MASTER with rear control unit

CST/F MASTER mit hinterem Steuergerät

CST/F MASTER con unidad de control trasera

CST/F MASTER avec unité de commande arrière

**UTENSILI vedere a pag. 208**

TOOLS see page 208

WERKZEUGE siehe Seite 208

HERRAMIENTAS ver página 208

OUTILS voir page 208

### Standard equipment

Joystick multifunzione

Multifunction joystick

Multifunktions-joystick







Joystick multifunción

Joystick multifonction

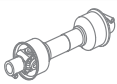

## CST/F MASTER

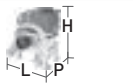
L'immagine della macchina è indicativa. Gli utensili e gli accessori sono a richiesta. – The picture of the machine is indicative. Tools and accessories are on request.

MOD							
mod.	cod.	HP	type	cm	cm	kg tot.	euro
<b>CST/F MASTER singolo</b>	1003091	30 - 100	T-50	145×130×100	90×97×112	625	<b>17.250,00</b>
<b>CST/F MASTER doppio</b>	1003092	30 - 100	T-60	180×130×100	90×97×112	750	<b>24.550,00</b>

Di serie	Standard equipment	Serienmässig	Estándar	De série
<ul style="list-style-type: none"> <li>Attacco a 3 punti Cat. II</li> <li>Centralina posteriore completa di serbatoio, sistema filtrante e scambiatore di calore</li> <li>Joystick multifunzione</li> <li>Spostamento laterale idraulico apertura/chiusura e regolazione dell'utensile</li> <li>Regolazione idraulica inclinazione dell'utensile</li> <li>Comando di emergenza</li> <li>Ruote di appoggio regolabili in altezza</li> <li>Doppio tastatore</li> <li>Kit lama scalzatrice</li> <li>Protezioni antinfortunistiche conformi alla normativa CE</li> </ul>	<ul style="list-style-type: none"> <li>3-point linkage cat. II</li> <li>Rear control unit complete with tank, filter system and heat exchanger</li> <li>Multifunction Joystick</li> <li>Hydraulic side shift opening/closing and tool adjustment</li> <li>Hydraulic tilt tool adjustment</li> <li>Emergency control</li> <li>Height-adjustable wheels</li> <li>Dual sensor</li> <li>Kit blade weeder and side deflectors for weeder blade</li> <li>Protective equipment as per EC safety rules</li> </ul>	<ul style="list-style-type: none"> <li>3-Punkt-Anbau Kat. II</li> <li>Hinterere Steuereinheit komplett mit Tank, Filtersystem und Wärmetauscher</li> <li>Multifunktions-Joystick</li> <li>Hydraulische Seitenverschiebung öffnen/schließen und Werkzeugverstellung</li> <li>Hydraulische Werkzeugneigungsverstellung</li> <li>Notfallsteuerung</li> <li>Höhenverstellbare Räder</li> <li>Doppelter Taster</li> <li>Kit Stockräumer</li> <li>Unfallschutz nach EU-Vorschriften</li> </ul>	<ul style="list-style-type: none"> <li>Enganche a 3 punto Cat. II</li> <li>Centralita posterior completa de depósito, sistema filtrante e intercambiador de calor</li> <li>Joystick multifunción</li> <li>Desplazamiento lateral hidráulico apertura/cierre y regulación del implemento</li> <li>Regulación hidráulica inclinación del implemento</li> <li>Comando de emergencia</li> <li>Rueda de apoyo con regulación en altura</li> <li>Palpador doble</li> <li>Kit cuchilla interfilare</li> <li>Protecciones de seguridad de acuerdo con la norma CE</li> </ul>	<ul style="list-style-type: none"> <li>Attelage 3 points Cat. II</li> <li>Unité de commande arrière complète avec réservoir, système de filtrage et échangeur de chaleur</li> <li>Joystick multifonction</li> <li>Déplacement latéral hydraulique pour ouverture/fermeture et réglage de l'outil</li> <li>Réglage hydraulique inclinaison de l'outil</li> <li>Commande d'urgence</li> <li>Roues de support réglables en hauteur</li> <li>Double palpeur</li> <li>Kit lame et sous-soleuses pour lame sarclouse</li> <li>Protections contre les accidents aux normes CE</li> </ul>



**CST/F MASTER**  
**CST/F MASTER**  
**CST/F MASTER**  
**CST/F MASTER**

TOOL CARRIER  
 GERÄTETRÄGER  
 BASTIDOR PORTAHERRAMIENTAS  
 CHÂSSIS PORTE-OUTILS



ORIGINAL MADE IN ITALY



**CST/F**

**MASTER**

cod.	A richiesta	On request	Auf Anfrage	Opcionales	Sur demande	€
5130005	Cardano T-50	PTO shaft T-50	Gelenkwelle T-50	Cardán T-50	Cardan T-50	273,00
5130009	Cardano T-60	PTO shaft T-60	Gelenkwelle T-60	Cardán T-60	Cardan T-60	300,00
5411041	Ruota in ferro senza cresta	Smooth iron wheel	Glatte Eisenräder	Rueda de hierro lisa	Roue en fer lisse	90,00



## CSR doppio PRO

CSR double PRO

CSR doppelt PRO

CSR doble PRO

CSR double PRO

**UTENSILI vedere a pag. 208**

TOOLS see page 208

WERKZEUGE siehe Seite 208

HERRAMIENTAS ver página 208

OUTILS voir page 208

CSR



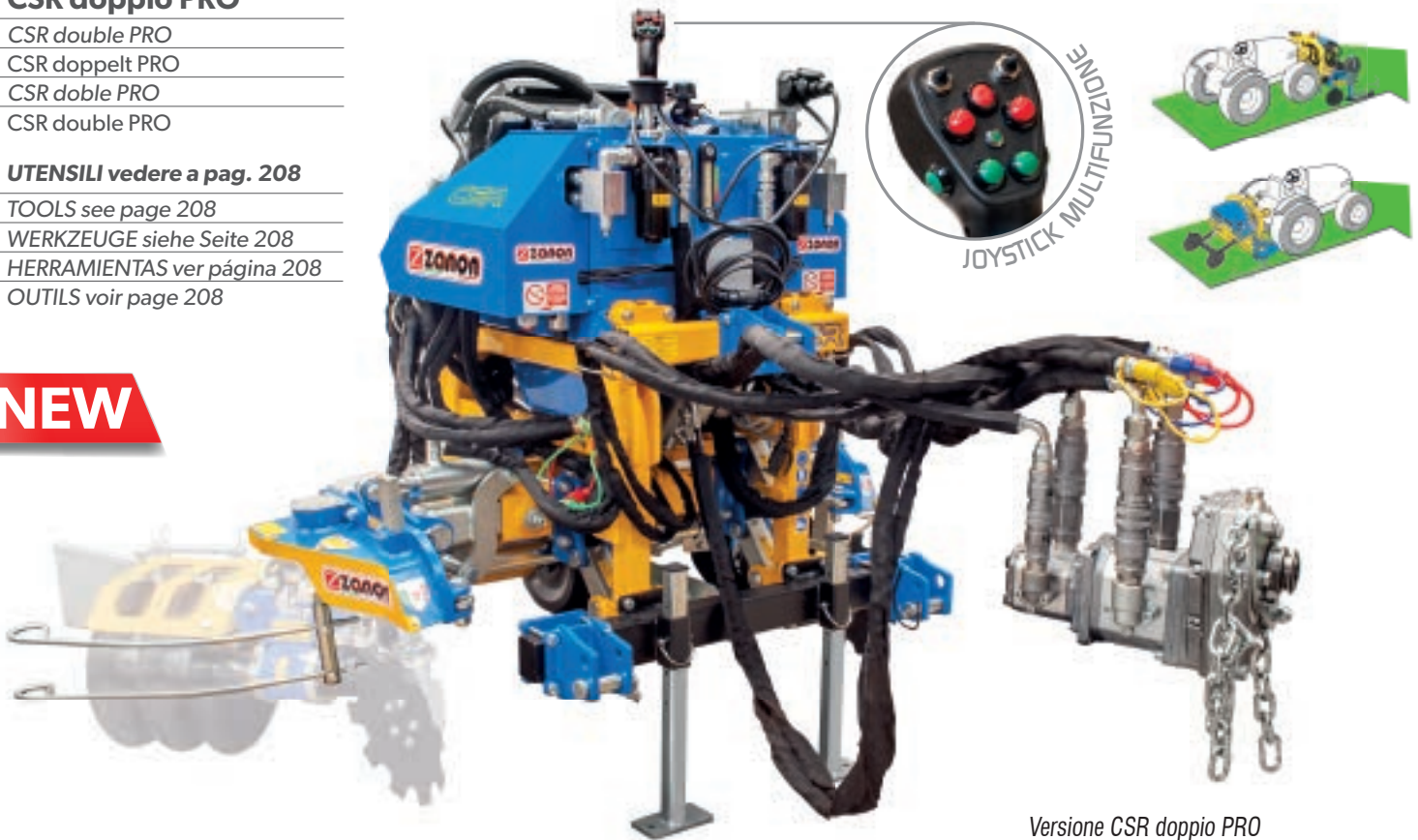



**NEW**



Versione CSR doppio PRO

L'immagine della macchina è indicativa. Gli utensili e gli accessori sono a richiesta. – The picture of the machine is indicative. Tools and accessories are on request.



MOD						
mod.	cod.	HP	cm	cm	kg tot.	euro
<b>CSR doppio PRO</b>	1003876	90 - 120	188×136×145	--	900	<b>25.600,00</b>
<b>CSR doppio MASTER</b>	1003877	90 - 120	188×136×145	90×97×112	1170	

Di serie	Standard equipment	Serienmässig	Estándar	De série
<ul style="list-style-type: none"> <li>Attacco a 3 punti cat. I-II</li> <li>Macchina reversibile</li> <li>Joystick multifunzione</li> <li>Regolazione idraulica altezza bracci di lavoro, apertura, inclinazione, accensione motori, richiamo utensile</li> <li>Doppia pompa</li> <li>Impianto oleodinamico completo di serbatoio, sistema filtrante e scambiatore di calore</li> <li>Comando di emergenza</li> <li>Ruote di appoggio con cresta regolabili in altezza e larghezza</li> <li>Doppio tastatore</li> <li>Kit lama scalzatrice</li> <li>Protezioni antifornitistiche conformi alla normativa CE</li> </ul>	<ul style="list-style-type: none"> <li>3-point linkage cat. I-II</li> <li>Reversible machine</li> <li>Multifunction Joystick</li> <li>Hydraulic height adjustment of working arm, opening, tilt, motor ignition, tool return</li> <li>Double pump</li> <li>Hydraulic system complete with tank, filter system and heat exchanger</li> <li>Emergency control</li> <li>Height and width-adjustable crest wheels</li> <li>Dual sensor</li> <li>Kit blade weeder</li> <li>Protective equipment as per EC safety rules</li> </ul>	<ul style="list-style-type: none"> <li>3-Punkt-Anbau Kat. I-II</li> <li>Maschine für Front- und Heckanbau</li> <li>Multifunktions-Joystick</li> <li>Hydraulische Einstellung der Höhe des Arbeitsarms, Öffnung, Neigung, Motorzündung, Werkzeugrücklauf</li> <li>Doppelpumpe</li> <li>Hydraulisches System komplett mit Tank, Filtersystem und Wärmetauscher</li> <li>Notfallsteuerung</li> <li>Höhen- und breitenverstellbare Räder mit Führung</li> <li>Doppelter Taster</li> <li>Kit Stockräumer</li> <li>Unfallschutz nach EU-Vorschriften</li> </ul>	<ul style="list-style-type: none"> <li>Enganche a 3 punto cat. I-II</li> <li>Máquina reversible</li> <li>Joystick multifunción</li> <li>Ajuste hidráulico de la altura del brazo de trabajo, apertura, inclinación, encendido del motor, retorno de la herramienta</li> <li>Bomba doble</li> <li>Sistema hidráulico completo con depósito, sistema de filtrado e intercambiador de calor</li> <li>Comando de emergencia</li> <li>Rueda de apoyo con regulación altura y anchura</li> <li>Palpador doble</li> <li>Kit cuchilla interfilar</li> <li>Protecciones de seguridad de acuerdo con la norma CE</li> </ul>	<ul style="list-style-type: none"> <li>Attelage 3 points cat. I-II</li> <li>Machine réversible</li> <li>Joystick multifonction</li> <li>Réglage hydraulique de l' hauteur du bras de travail, de l'ouverture, de l'inclinaison, de l'allumage du moteur, du retour de l'outil</li> <li>Pompe double</li> <li>Système hydraulique complet avec réservoir, système de filtration et échangeur de chaleur</li> <li>Commande de secours</li> <li>Roues de support avec guide réglables en hauteur et en largeur</li> <li>Palpeur double</li> <li>Kit lame sarclouse</li> <li>Protections contre les accidents aux normes CE</li> </ul>

cod.	A richiesta	On request	Auf Anfrage	Opcionales	Sur demande	€
5411041	Ruota in ferro senza cresta	Smooth iron wheel	Glatte Eisenräder	Rueda de hierro lisa	Roue en fer lisse	<b>90,00</b>
2051346	Cilindro regolazione idraulica ruote	Hydraulic wheel adjustment cylinder	Hydraulischer Radeinstellzylinder	Cilindro hidráulico para ajuste la altura de la rueda	Cylindre hydraulique de réglage des roues	<b>325,00</b>
2051338	Kit GPS control 4.0	GPS control 4.0 kit	GPS-Steuerung 4.0-Kit	Kit de control GPS 4.0	Kit de contrôle GPS 4.0	<b>4.550,00</b>

CSR	DOUBLE TOOL CARRIER
CSR	DOPPELTER GERÄTETRÄGER
CSR	PORTAHERRAMIENTAS DOBLE
CSR	DOUBLE CHÂSSIS PORTE-OUTILS

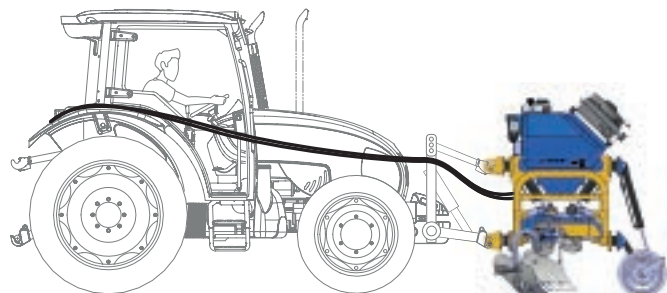
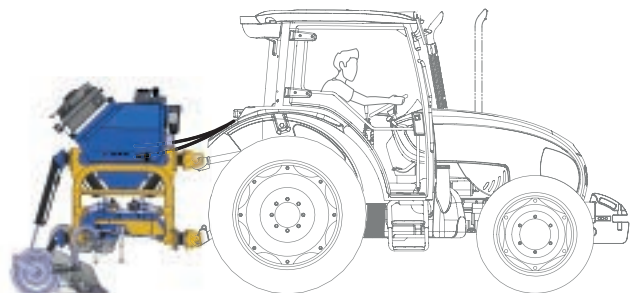

**CSR doppio PRO (lavoro posteriore)**

- CSR double PRO (rear work)
- CSR doppelt PRO (Arbeit hinten)
- CSR doble PRO (trasero)
- CSR double PRO (travail arrière)

**CSR doppio PRO (lavoro anteriore)**

- CSR double PRO (front work)
- CSR doppelt PRO (Arbeit vorne)
- CSR doble PRO (delantero)
- CSR double PRO (travail frontal)

**CSR doppio MASTER con centralina CNT**

- CSR double MASTER with CNT control unit
- CSR doppelt MASTER mit CNT-Steuergerät
- CSR doble MASTER con unidad de control CNT
- CSR double MASTER avec unité de contrôle CNT

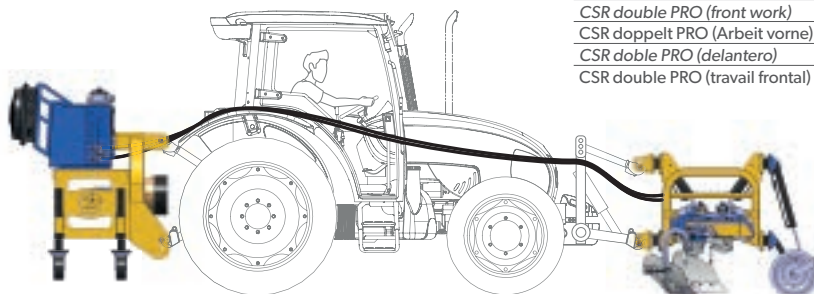

**MOVIMENTI DEI BRACCI - ARM MOVEMENTS - ARM-BEWEGUNGEN - MOVIMIENTOS DE LOS BRAZOS - MOUVEMENTS DES BRAS**

Regolazione in altezza indipendente dx e sx  
 Independent height adjustment left and right  
 Unabhängige Höhenverstellung links und rechts  
 Ajuste de altura independiente a izquierda y derecha  
 Réglage indépendant de la hauteur à gauche et à droite

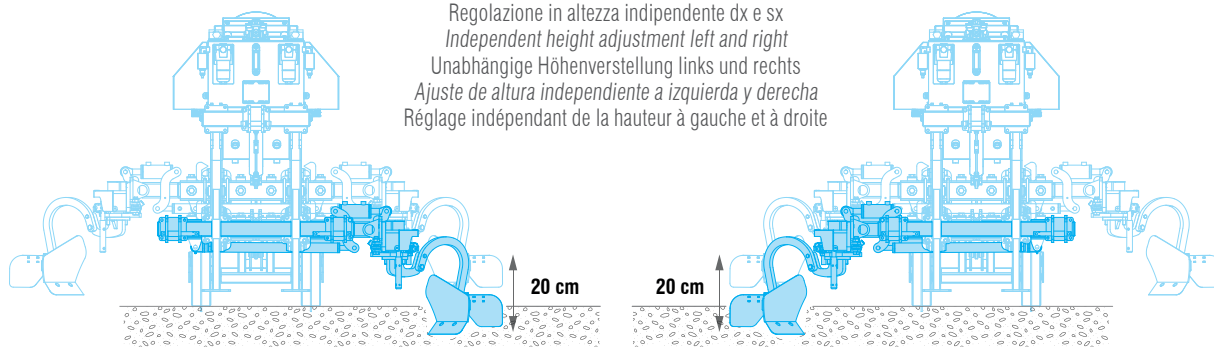

Regolazione larghezza di lavoro  
 Working width adjustment  
 Einstellung der Arbeitsbreite  
 Ajuste del ancho de trabajo  
 Réglage de la largeur de travail

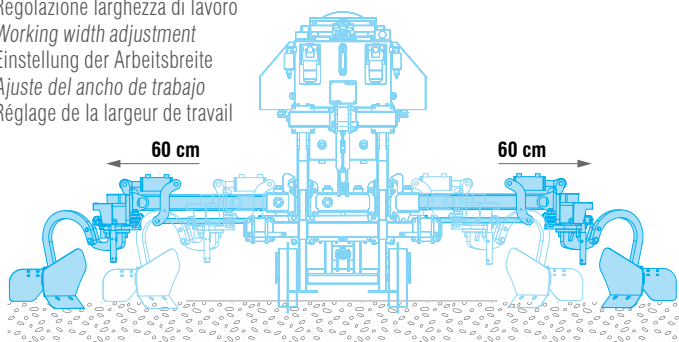

Inclinazione testata  
 Head tilting  
 Neigung des Kopfes  
 Inclinación del cabezal  
 Inclinaison de la tête

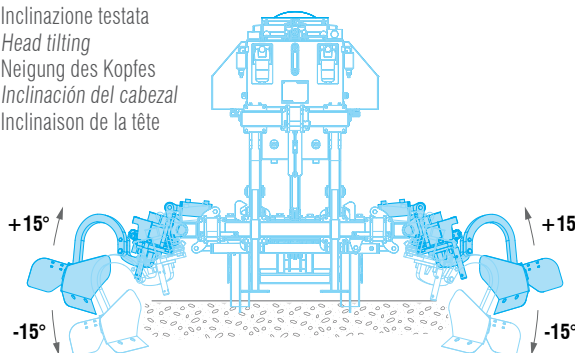

**LARGHEZZA FILARE MIN/MAX - MIN/MAX ROW WIDTH - MIN/MAX ZEILENBREITE - ANCHURA MÍN/MÁX DE LA FILA - LARGEUR MIN/MAX DE LA LIGNE**

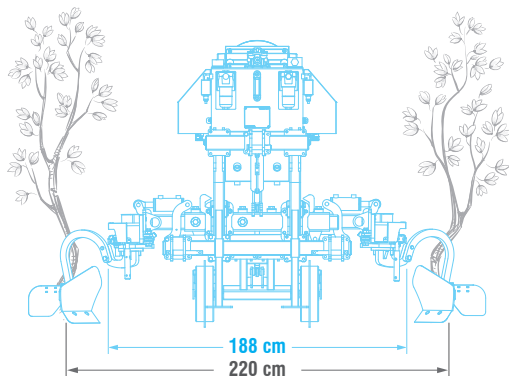

Le misure possono variare a seconda dell'attrezzo applicato.

Measurements may vary depending on the tool applied.

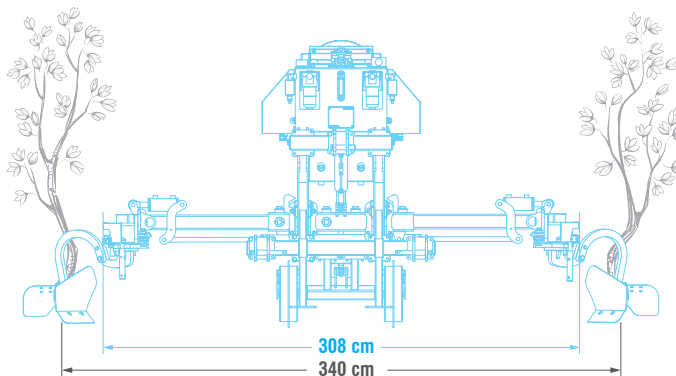

Die Abmessungen können je nach dem verwendeten Werkzeug variieren.

Las medidas pueden variar en función de la herramienta aplicada.

Les mesures peuvent varier en fonction de l'outil utilisé.

<b>CNT</b>	HYDRAULIC CONTROL UNIT
<b>CNT</b>	HYDRAULIK STEUERGERÄT
<b>CNT</b>	CENTRAL HIDRÁULICA
<b>CNT</b>	CENTRALE HYDRAULIQUE

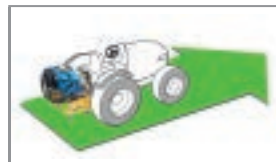
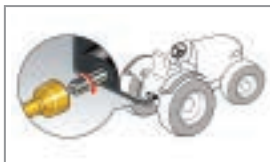

MOD							
mod.	cod.	HP	l/min	bar	cm	kg tot.	euro
<b>CNT singola</b>	1003171	30 - 100	45	max 180	90×97×112	235	<b>5.150,00</b>
<b>CNT doppia</b>	1003089	30 - 100	45 + 45	max 180	90×97×112	270	<b>5.800,00</b>

Di serie	Standard equipment	Serienmässig	Estándar	De série
<ul style="list-style-type: none"> <li>• Attacco a 3 punti Cat. II</li> <li>• Centralina idraulica completa di:               <ul style="list-style-type: none"> <li>- serbatoio,</li> <li>- sistema filtrante</li> <li>- scambiatore di calore con termostato</li> <li>- valvola di massima</li> </ul> </li> <li>• Ruote di appoggio regolabili in altezza</li> <li>• Freno di stazionamento per rimessaggio</li> <li>• innesti rapidi:               <ul style="list-style-type: none"> <li>- 1 mandata e 2 scarichi (versione singola),</li> <li>- 2 mandata e 4 scarichi (versione doppia)</li> </ul> </li> <li>• Protezioni antinfortunistiche conformi alla normativa CE</li> </ul>	<ul style="list-style-type: none"> <li>• 3-point linkage cat. II</li> <li>• Hydraulic control unit complete with:               <ul style="list-style-type: none"> <li>- tank</li> <li>- filter system</li> <li>- heat exchanger with thermostat</li> <li>- relief valve</li> </ul> </li> <li>• Height-adjustable wheels</li> <li>• Parking brake for storage</li> <li>• Quick couplings:               <ul style="list-style-type: none"> <li>- 1 delivery and 2 drainage (single version),</li> <li>- 2 delivery and 4 drainages (double version)</li> </ul> </li> <li>• Protective equipment as per EC safety rules</li> </ul>	<ul style="list-style-type: none"> <li>• 3-Punkt-Anbau Kat. II</li> <li>• Hydraulik Steuergerät komplett mit:               <ul style="list-style-type: none"> <li>- Tank</li> <li>- Filtersystem</li> <li>- Wärmetauscher mit Thermostat</li> <li>- Entlastungsventil</li> </ul> </li> <li>• Höhenverstellbare Räder</li> <li>• Feststellbremse zur Aufbewahrung</li> <li>• Schnellkupplungen:               <ul style="list-style-type: none"> <li>- 1 Druckleitung und 2 Ölableitungen (Einzelversion),</li> <li>- 2 Druckleitungen und 4 Ölableitungen (Doppelversion)</li> </ul> </li> <li>• Unfallschutz nach EU-Vorschriften</li> </ul>	<ul style="list-style-type: none"> <li>• Erganche a 3 punto Cat. II</li> <li>• Central hidráulica completa de:               <ul style="list-style-type: none"> <li>- depósito (litros)</li> <li>- sistema filtrante</li> <li>- intercambiador de calor con termostato</li> <li>- válvula de seguridad</li> </ul> </li> <li>• Rueda de apoyo con regulación en altura</li> <li>• Freno de estacionamiento para almacenamiento</li> <li>• Enchufes rápidos:               <ul style="list-style-type: none"> <li>- 1 impulsión y 2 retorno (versión simple),</li> <li>- 2 impulsión y 4 retorno (versión doble)</li> </ul> </li> <li>• Protecciones de seguridad de acuerdo con la norma CE</li> </ul>	<ul style="list-style-type: none"> <li>• Attelage 3 points Cat. II</li> <li>• Unité de commande hydraulique complète avec:               <ul style="list-style-type: none"> <li>- réservoir</li> <li>- système de filtrage</li> <li>- échangeur de chaleur avec thermostat</li> <li>- soupape de surpression</li> </ul> </li> <li>• Roues de support réglables en hauteur</li> <li>• Frein de stationnement pour le stockage</li> <li>• Raccords rapides:               <ul style="list-style-type: none"> <li>- 1 refoulement et 2 échappements (version simple),</li> <li>- 2 refoulements et 4 échappements (version double)</li> </ul> </li> <li>• Protections contre les accidents aux normes CE</li> </ul>

# GPS CONTROL 4.0

## TUTTO IL LAVORO SOTTO CONTROLLO



### SISTEMA AVANZATO PER LA GESTIONE, LA SICUREZZA E LA DIAGNOSTICA DA REMOTO

Il piano Industria 4.0 rappresenta, per i clienti che usufruiranno di questa tecnologia, un'opportunità unica per investire in macchinari di alta qualità attraverso uno sconto fiscale in forma di credito d'imposta pari al 50% del valore del bene acquistato (Piano I4.0).

Inoltre la centralina 4.0 ti darà la possibilità di avere accesso ai valori dati dai sensori (per es. temperatura, pressione dell'olio, RPM) e, attraverso una piattaforma Cloud personalizzata ed un sistema di controllo GPS, è possibile raccogliere ed analizzare i dati di lavoro da computer o mobile.

- Geolocalizzazione: GPS CONTROL 4.0 permette di impostare un'area di lavoro predefinita e rileva costantemente le informazioni sulla posizione della macchina e la sua velocità.
- Sensori per la temperatura e la pressione dell'olio nell'impianto, sensore di controllo del numero di giri della PTO
- QR code per connettersi in modo rapido e veloce al portale web e conoscere in tempo reale i dati rilevati dai sensori, le ore di funzionamento e gli avvisi relativi alla manutenzione programmata.

#### Macchine sulle quali è possibile applicare la centralina 4.0:

- CST PRO singolo e doppio
- CST-F MASTER singolo e doppio
- CTV-PRO (sensore numero giri escluso)
- IT-PRO
- CST-DMI singola e singola compatta
- CST-DMI doppia e doppia compatta
- ITE e ITF

## UTENSILI

WORKING TOOLS

WERKZEUGE

HERRAMIENTAS DE TRABAJO

OUTILS DE TRAVAIL

CST





CST/F

CST/F MASTER

**Kit ancora aprisolco**  
*Kit anchor fixed*  
**Kit Zinken Fest**  
*Kit punta abre surco*  
**Kit ancre**

			
cod.	kg	euro	
2050687	8	140,00	

**Kit disco aprisolco**  
*Kit disc fixed*  
**Kit Scheibpflug fest**  
*Disco de corte*  
**Kit disque**

			
cod.	kg	euro	
2050690 DX	8	460,00	
2050691 SX	8	460,00	

**Kit ruota di profondità**  
*Kit depth wheel*  
**Kit Tiefenräd**  
*Kit rueda de profundidad*  
**Kit roue de profondeur**

			
cod.	kg	euro	
2051277	9	295,00	

### LSI







**Kit lama scalzatrice**  
*con ala laterale ed esplorori*

**Kit blade weeder and side defectors**  
*for weeder blade*

**Kit Stockräumer und Deflektoren**  
*für Abraumschar*

**Kit cuchilla interfilare y aletas**  
*para cuchilla binadora*

**Kit lame et sous-soleuses**  
*pour lame sarceuse*

						
cod.	cm	cm	cm	cm	kg	euro
2050681 DX	L = 55	125	125	125	10	420,00
2050682 SX		185	185	185	10	420,00
2051364 DX	L = 70	140	140	140	11	440,00
2051365 SX		200	200	200	11	440,00

**NEW**







**Kit fresino circolare idraulico**  
*per lama scalzatrice*

**Kit rotary cultivator for blade weeder**

**Kit Zinkenkreisel für Stockräumer**

**Kit fresa circular hidráulica**  
*para cuchilla interfilare*

**Kit hydraulique fraise**  
*circulaire pour lame sarceuse*

						
cod.	cm	cm	l/min	kg	euro	
2051273	125	125	30	25	1.020,00	
	185	185				

Solo con lama scalzatrice L=55 cm - Only with blade weeder L=55 cm - Nur mit Abraumschar L=55 cm - Sólo con cuchilla interfilare L=55 cm - Uniquement avec lame sarceuse L=55 cm







**Kit lama paraterra per CST posteriore**  
*solo per:*  
*Kit aratro scalzatore e*  
*Kit dischi scalzatori idraulici*

**Kit soil & stone deflector for rear CST**  
*only for:*  
*Kit plough*  
*Kit hydraulic discs*

**Kit Erd- & Steinschieber für hinteres CST**  
*nur für:*  
*Kit Pflug*  
*Kit angetrieben Scheiben*

**Kit cuchilla para-tierra para CST trasero**  
*solo para:*  
*Kit arado desaporcador*  
*Kit grada de discos*

**Kit lame convoyeur de terre pour CST arrière**  
*uniquement pour:*  
*Kit charrue et*  
*Kit disques dechausseuse*

						
cod.	cm	cm	l/min	kg	euro	
2050685 DX	90	90	--	25	920,00	
2050686 SX	150	150	--	25	920,00	

CST	CST/F	CST/F MASTER	TOOL CARRIER
CST	CST/F	CST/F MASTER	GERÄTETRÄGER
CST	CST/F	CST/F MASTER	BASTIDOR PORTAHERRAMIENTAS
CST	CST/F	CST/F MASTER	CHÂSSIS PORTE-OUTILS



ORIGINAL MADE IN ITALY

**Kit lama paraterra per CST anteriore**  
solo per:  
Kit aratro scalzatore e  
Kit dischi scalzatori idraulici

**Kit soil & stone deflector for front CST**  
only for:  
Kit plough  
Kit hydraulic discs

**Kit Erd- & Steinschieber für vordere CST**  
nur für:  
Kit Pflug  
Kit angetrieben Scheiben

**Kit cuchilla para-tierra para CST frontal**  
solo para:  
Kit arado desaporcador  
Kit grada de discos

**Kit lame convoyeur de terre pour CST avant**  
uniquement pour:  
Kit charrue et  
Kit disques dechausseuse



cod.	cm	cm	cm	cm	l/min	kg	euro	
2050804 DX	90	90	90	90	--	25	920,00	
2050805 SX	150	150	150	150	--	25	920,00	

### DSL 2

**Kit dischi scalzatori (2 dischi)**  
2 dischi in parallelo  
con spatola pulisci ceppo.  
Profondità di lavoro 7 cm

**Kit hydraulic discs (2 discs)**  
2 discs can be fitted in parallel  
with row cleaner blade.  
Working depth 7 cm

**Kit angetrieben Scheiben (2)**  
2 Scheiben können parallel mit  
Reihenreiwigungsmesser montiert  
werden. Arbeitstiefe 7 cm

**Kit grada de discos (2 discos)**  
Posibilidad de montar 2 discos  
paralelos, con espátula limpia cepas.  
Profundidad de trabajo 7 cm

**Kit disques dechausseuse (2)**  
Possibilité de monter 2 disques en  
parallèle, avec spatule de nettoyage  
des cepes. Profondeur de travail 7 cm



cod.	cm	cm	cm	cm	l/min	kg	euro	
2050868 DX	120	120	120	120	30	45	1.850,00	
2050869 SX	180	180	180	180	30	45	1.850,00	

### DSL 3

**Kit dischi scalzatori (3 dischi)**  
3 dischi in parallelo  
con spatola pulisci ceppo.  
Profondità di lavoro 7 cm

**Kit hydraulic discs (3 discs)**  
3 discs can be fitted in parallel  
with row cleaner blade.  
Working depth 7 cm

**Kit angetrieben Scheiben (3)**  
3 Scheiben können parallel mit  
Reihenreiwigungsmesser montiert  
werden. Arbeitstiefe 7 cm

**Kit grada de discos (3 discos)**  
Posibilidad de montar 3 discos  
paralelos, con espátula limpia cepas.  
Profundidad de trabajo 7 cm

**Kit disques dechausseuse (3)**  
Possibilité de monter 3 disques en  
parallèle, avec spatule de nettoyage  
des cepes. Profondeur de travail 7 cm



cod.	cm	cm	cm	cm	l/min	kg	euro	
2050694 DX	130	130	130	130	30	50	2.050,00	
2050695 SX	190	190	190	190	30	50	2.050,00	

### DRT

NEW

**Kit dischi rinalzatori trainati, 2 dischi in parallelo**  
Profondità di lavoro 7 cm

**Kit trailed ridging discs**  
2 discs in line  
Working depth 7 cm

**Kit Gezogenes Scheiben zum Häufeln, 2 Scheiben parallel**  
Arbeitstiefe 7 cm

**Kit discos para recalzar arrastrado**  
2 discos en paralelo  
Profundidad de trabajo 7 cm

**Kit disques émotteurs trainés**  
2 disques en parallèle  
Profondeur de travail 7 cm



cod.	cm	cm	cm	cm	l/min	kg	euro	
2051182 DX	120	120	120	120	30	25	1.350,00	
2051183 SX	180	180	180	180	30	25	1.350,00	

### DRM

NEW

**Kit dischi rinalzatori motorizzati, 2 dischi in parallelo**  
Profondità di lavoro 7 cm

**Kit motorized ridging discs, 2 discs in line**  
Working depth 7 cm

**Kit Motorisiertes Scheiben zum Häufeln, 2 Scheiben parallel**  
Arbeitstiefe 7 cm

**Kit discos para recalzar motorizado, 2 discos en paralelo**  
Profundidad de trabajo 7 cm

**Kit disques émotteurs motorisés, 2 disques en parallèle**  
Profondeur de travail 7 cm



cod.	cm	cm	cm	cm	l/min	kg	euro	
2051291 DX	120	120	120	120	30	30	2.250,00	
2051292 SX	180	180	180	180	30	30	2.250,00	

## ASI

**Kit aratro scalzatore**  
con spatola pulisci ceppo.  
Profondità di lavoro max 15 cm

**Kit plough**  
with row cleaner blade.  
Working depth max. 15 cm

**Kit Pflug**  
mit Säuberungschar.  
Max. Arbeitstiefe 15 cm

**Kit arado desporcador**  
con espátula limpia cepas.  
Profundidad de trabajo máx. 15 cm

**Kit charrue**  
avec spatule de nettoyage des cepes.  
Profondeur de travail max 15 cm



cod.		cm	cm	l/min	kg	euro
2050683	DX	128	128   128	--	18	990,00
2050684	SX	188	188   188	--	18	990,00

## RFI

**Kit rotofresa idraulico**  
3 denti fresa  
Ø di lavoro 35 cm  
Paraterra regolabile

**Kit hydraulic rotary tiller**  
3-Teeth tiller  
Working Ø 35 cm  
Soil & stone deflector adjustable

**Kit Zinkenkreisel**  
3 Zähne Fräse  
Ø Arbeit 35 cm  
Erd- & Steinschieber verstellbar

**Kit roto fresa hidraulica**  
3 dientes fresa  
Ø de trabajo 35 cm  
Cuchilla para-tierra ajustable

**Kit roto-fraise hydraulique**  
3 dents fraise  
Ø de travail 35 cm  
Lame convoyeur de terre réglable



cod.		cm	cm	l/min	kg	euro
2050688	DX	122	122   122	30	45	1.920,00
2050689	SX	182	182   182	30	45	1.920,00

## RPC

**Erpice interceppo**  
Larghezza di lavoro 40 cm

**Inter-row power harrow**  
Working width 40 cm

**Kreislegge**  
Arbeitsbreite 40 cm

**Grada inter-fila**  
Ancho de trabajo 40 cm

**Herse rotative**  
Largeur de travail 40 cm



cod.		cm	cm	l/min	kg	euro
2051137	DX	130	130   130	30	67	3.980,00
2051138	SX	190	190   190	30	67	3.980,00

## MT

**Kit minitricia**  
Larghezza di lavoro 70 cm

**Kit mulcher**  
Working width 70 cm

**Kit Mulcher**  
Arbeitsbreite 70 cm

**Kit minitrituradora**  
Ancho de trabajo 70 cm

**Kit mini-broyeur**  
Largeur de travail 70 cm



cod.		cm	cm	l/min	kg	euro
2050792	DX	155	155   155	30	70	2.790,00
2050793	SX	215	215   215	30	70	2.790,00

## DMI

**Kit diserbatrice**  
Larghezza di lavoro 70 cm

**Kit inter-row weeder**  
Working width 70 cm

**Kit unkrutmähbürste**  
Arbeitsbreite 70 cm

**Kit desbrozadora**  
Ancho de trabajo 70 cm

**Kit machine à ébourgeonner**  
Largeur de travail 70 cm

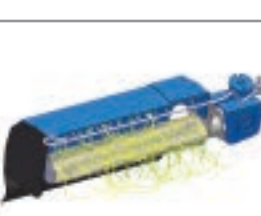

cod.		cm	cm	l/min	kg	euro
2051176	DX	165	165   165	30	40	2.880,00
2051177	SX	225	225   225	30	40	2.880,00



CST	CST/F	CST/F MASTER	TOOL CARRIER
CST	CST/F	CST/F MASTER	GERÄTETRÄGER
CST	CST/F	CST/F MASTER	BASTIDOR PORTAHERRAMIENTAS
CST	CST/F	CST/F MASTER	CHÂSSIS PORTE-OUTILS



## SPR

Kit spollonatrice Larghezza di lavoro 56 cm	Kit shoot remover Working width 56 cm	Kit Stockputzer Arbeitsbreite 56 cm	Kit removedor de brotes Ancho de trabajo 56 cm	Kit brosse rotative Largeur de travail 56 cm		
	cod.	cm	cm	l/min	kg	euro
	2050845 DX	165	165 : 165	30	40	2.290,00
	2050846 SX	225	225 : 225	30	40	2.290,00

## IT - Ø50 LAME

Kit testata IT lame 2 lame Ø di lavoro 50 cm	Kit disc-mower IT blades 2 blades Working Ø 50 cm	Scheibenmäher IT Messerklingen 2 Messerklingen Arbeits-Ø 50 cm	Kit cabezal interfila IT cuchilla 2 cuchilla Ø de trabajo 50 cm	Kit disque satellite IT lames 2 lames Ø de travail 50 cm		
	cod.	cm	cm	l/min	kg	euro
	2050823 DX	140	140 : 140	30	35	2.490,00
	2050824 SX	200	200 : 200	30	35	2.490,00

## IT - Ø70 LAME

Kit testata IT lame 2 lame Ø di lavoro 70 cm	Kit disc-mower IT blades 2 blades Working Ø 70 cm	Scheibenmäher IT Messerklingen 2 Messerklingen Arbeits-Ø 70 cm	Kit cabezal interfila IT cuchilla 2 cuchilla Ø de trabajo 70 cm	Kit disque satellite IT lames 2 lames Ø de travail 70 cm		
	cod.	cm	cm	l/min	kg	euro
	2050825 DX	147	147 : 147	30	37	2.660,00
	2050826 SX	207	207 : 207	30	37	2.660,00

## ITF - Ø50 FILO

Kit testata IT filo 4 Fili (8 taglianti) Ø 6 Ø di lavoro 50 cm	Kit disc-mower IT wire 4 wires (8 cutting edges) Ø 6 Working Ø 50 cm	Kit Scheibenmäher IT Faden 4 Drähte (8 Schneidkanten) Ø 6 Arbeits-Ø 50 cm	Kit cabezal interfila IT hilo 4 hilos (8 filos de corte) Ø 6 Ø de trabajo 50 cm	Kit disque satellite IT fil 4 fils (8 tranchants) Ø 6 Ø de travail 50 cm		
	cod.	cm	cm	l/min	kg	euro
	2050827 DX	140	140 : 140	30	32	2.140,00
	2050828 SX	200	200 : 200	30	32	2.140,00

## ITF - Ø70 FILO

Kit testata IT filo 4 Fili (8 taglianti) Ø 6 Ø di lavoro 70 cm	Kit disc-mower IT wire 4 wires (8 cutting edges) Ø 6 Working Ø 70 cm	Kit Scheibenmäher IT Faden 4 Drähte (8 Schneidkanten) Ø 6 Arbeits-Ø 70 cm	Kit cabezal interfila IT hilo 4 hilos (8 filos de corte) Ø 6 Ø de trabajo 70 cm	Kit disque satellite IT fil 4 fils (8 tranchants) Ø 6 Ø de travail 70 cm		
	cod.	cm	cm	l/min	kg	euro
	2050829 DX	147	147 : 147	30	37	2.310,00
	2050830 SX	207	207 : 207	30	37	2.310,00

## UTENSILI

WORKING TOOLS

WERKZEUGE







HERRAMIENTAS DE TRABAJO







OUTILS DE TRAVAIL

CST







CST/F

CST/F MASTER







Kit disco anteriore rollhacke	Kit rollhacke front disc	Kit Rollhacke front	Kit disco anterior rollhacke	Kit disque antérieur rollhacke	
					
					
cod.	cm	cm	l/min	kg	euro
2050919 DX	92	92   92	--	14	950,00
2050920 SX	152	152   152	--	14	950,00

Kit disco anteriore rollhacke doppio "BOOMERANG"	Kit double rollhacke front discs "BOOMERANG"	Kit Doppel-Rollhacke front "BOOMERANG"	Kit disco anterior rollhacke doble "BOOMERANG"	Kit disque antérieur rollhacke double "BOOMERANG"	
					
					
cod.	cm	cm	l/min	kg	euro
2050921 DX	102	102   102	--	28	1.150,00
2050922 SX	162	162   162	--	28	1.150,00

### Ø 540

Disco sarchiatore a dita Disco stella Ø 540 Densità dura - Colore rosso	Finger weeder Star disc Ø 540 Hard density - Red color	Fingerhacke Sternscheibe Ø 540 Harte Dichte - Rote Farbe	Disco cultivador a dedos Disco estrella Ø 540 Densidad dura - Color rojo	Disque sarclage à doigts Disque étoile Ø 540 Densité dure - Couleur rouge	
					
					
cod.	cm	cm	l/min	kg	euro
2050913 DX	108	108   108	--	36	1.750,00
2060583 SX	182	182   182	--	36	1.750,00

### Ø 700

Disco sarchiatore a dita Disco stella Ø 700 Densità dura - Colore rosso	Finger weeder Star disc Ø 700 Hard density - Red color	Fingerhacke Sternscheibe Ø 700 Harte Dichte - Rote Farbe	Disco cultivador a dedos Disco estrella Ø 700 Densidad dura - Color rojo	Disque sarclage à doigts Disque étoile Ø 700 Densité dure - Couleur rouge	
					
					
cod.	cm	cm	l/min	kg	euro
2050916 DX	120	120   120	--	50	2.370,00
2060586 SX	192	192   192	--	50	2.370,00

CST	CST/F	CST/F MASTER	TOOL CARRIER
CST	CST/F	CST/F MASTER	GERÄTETRÄGER
CST	CST/F	CST/F MASTER	BASTIDOR PORTAHERRAMIENTAS
CST	CST/F	CST/F MASTER	CHÂSSIS PORTE-OUTILS



# UTENSILI

## WORKING TOOLS

## WERKZEUGE





## HERRAMIENTAS DE TRABAJO

## OUTILS DE TRAVAIL





**CST**  
**CST/F**  
**CST/F MASTER**

CST UTENSILI





Ø 540

Disco sarchiatore a dita Disco stella Ø 540 Densità media - Colore giallo	Finger weeder Star disc Ø 540 Medium density - Yellow color	Fingerhacke Sternscheibe Ø 540 Mittlere Dichte - Gelbe Farbe	Disco cultivador a dedos Disco estrella Ø 540 Densidad media - Color amarillo	Disque sarclage à doigts Disque étoile Ø 540 Densité moyenne - Couleur jaune		
						
	cod.	cm	cm	l/min	kg	euro
	2050915 DX	108	108 : 108	--	36	1.750,00
	2060585 SX	182	182 : 182	--	36	1.750,00





Ø 700

Disco sarchiatore a dita Disco stella Ø 700 Densità media - Colore giallo	Finger weeder Star disc Ø 700 Medium density - Yellow color	Fingerhacke Sternscheibe Ø 700 Mittlere Dichte - Gelbe Farbe	Disco cultivador a dedos Disco estrella Ø 700 Densidad media - Color amarillo	Disque sarclage à doigts Disque étoile Ø 700 Densité moyenne - Couleur jaune		
						
	cod.	cm	cm	l/min	kg	euro
	2050918 DX	120	120 : 120	--	50	2.370,00
	2060588 SX	192	192 : 192	--	50	2.370,00

Ø 540

Disco sarchiatore a dita Disco stella Ø 540 Densità morbida - Colore arancione	Finger weeder Star disc Ø 540 Soft density - Orange color	Fingerhacke Sternscheibe Ø 540 Weiche Dichte - Orange Farbe	Disco cultivador a dedos Disco estrella Ø 540 Densidad suave - Color naranja	Disque sarclage à doigts Disque étoile Ø 540 Densité douce - Couleur orange		
						
	cod.	cm	cm	l/min	kg	euro
	2050914 DX	108	108 : 108	--	36	1.750,00
	2060584 SX	182	182 : 182	--	36	1.750,00

Ø 700

Disco sarchiatore a dita Disco stella Ø 700 Densità morbida - Colore arancione	Finger weeder Star disc Ø 700 Soft density - Orange color	Fingerhacke Sternscheibe Ø 700 Weiche Dichte - Orange Farbe	Disco cultivador a dedos Disco estrella Ø 700 Densidad suave - Color naranja	Disque sarclage à doigts Disque étoile Ø 700 Densité douce - Couleur orange		
						
	cod.	cm	cm	l/min	kg	euro
	2050917 DX	120	120 : 120	--	50	2.370,00
	2060587 SX	192	192 : 192	--	50	2.370,00

## VERSIONE BASE

BASIC VERSION

BASISVERSION

VERSIÓN BÁSICA

VERSION DE BASE

**UTENSILI vedere a pag. 216**

TOOLS see page 216

WERKZEUGE siehe Seite 216

HERRAMIENTAS ver página 216

OUTILS voir page 216

## Standard equipment

Joystick multifunzione

Multifunction joystick

Multifunktions-joystick

Joystick multifunción

Joystick multifonction



JOYSTICK MULTIFUNZIONE









CTV BASE



## CTV BASE

L'immagine della macchina è indicativa. Gli utensili e gli accessori sono a richiesta. – The picture of the machine is indicative. Tools and accessories are on request.

MOD							
mod.	cod.	HP	nr	cm	cm	kg	euro
CTV 140 Base	1003093	40 - 60	3 *	15	160×195×110	500	11.550,00
CTV 160 Base	1003094	70 - 90	5 *	15	180×195×110	550	12.450,00
CTV 180 Base	1003095	70 - 90	5 *	15	200×195×110	600	12.600,00
CTV 200 Base	1003104	70 - 90	7 *	15	220×195×110	700	13.650,00
CTV 220 Base	1003105	70 - 90	7 *	15	240×195×110	725	13.900,00
CTV 240 Base	1003106	70 - 90	7 *	15	260×195×110	750	15.350,00

\*+2 ancore a molla con vomerini da 26 cm a richiesta \*+2 spring-loaded anchors with 26 cm ploughshares on request \*+2 Federbelastete Zinken mit 26 cm Pflugscharen auf Anfrage  
\*+2 punta a muelle con reja de 26 cm bajo pedido \*+2 anclas a ressort avec socs de 26 cm sur demande

\* Indicare il modello del rullo al momento dell'ordine \* When ordering, the roller model must be indicated \* Bei der Bestellung muss das Rollmodell angegeben werden \* Indique el modelo del rodillo al realizar el pedido. \* Indiquez le modèle du rouleau lors de la commande

Di serie	Standard equipment	Serienmässig	Estándar	De série
<ul style="list-style-type: none"> <li>Attacco a 3 punti Cat. II</li> <li>Impianto idraulico alimentato dal trattore</li> <li>Joystick multifunzione</li> <li>Spostamento laterale idraulico apertura/chiusura</li> <li>2 bracci portattrezzi completi di doppio tastatore</li> <li>Regolazione meccanica altezza di lavoro bracci laterali indipendente dalle ancore a molla</li> <li>Ancore a molla con vomerini da 26 cm</li> <li>Rullo posteriore dentato o a gabbia (da specificare in fase d'ordine) regolabile in altezza</li> <li>Protezioni antifortunistiche conformi alla normativa CE</li> </ul>	<ul style="list-style-type: none"> <li>3-point linkage cat. II</li> <li>Tractor-powered hydraulics</li> <li>Multifunction Joystick</li> <li>Hydraulic side shift opening/closing</li> <li>2 tool-holding arms complete with double sensor</li> <li>Mechanical adjustment of working height of side arms independent of spring anchors</li> <li>Spring-loaded anchors with 26 cm ploughshares</li> <li>Rear toothed or cage roller (to be specified when ordering) adjustable in height</li> <li>Protective equipment as per EC safety rules</li> </ul>	<ul style="list-style-type: none"> <li>3-Punkt-Anbau Kat. II</li> <li>Traktorbetriebenes Hydrauliksystem</li> <li>Multifunktions-Joystick</li> <li>Hydraulische Seitenverschiebung öffnen/schließen</li> <li>2 Geräteträger-Arme komplett mit Doppeltaster</li> <li>Mechanische Einstellung der Arbeitshöhe der Seitenarme unabhängig von den Federankern</li> <li>Federbelastete Zinken mit 26 cm Pflugscharen</li> <li>Höhenverstellbare Gezähnte- oder Stabwalze (bei Bestellung anzugeben)</li> <li>Unfallschutz nach EU-Vorschriften</li> </ul>	<ul style="list-style-type: none"> <li>Enganche a 3 punto Cat. II</li> <li>Sistema hidráulico alimentado por el tractor</li> <li>Joystick multifunción</li> <li>Desplazador lateral hidráulico apertura/cierre</li> <li>2 brazos porta herramienta completos de doble palpador</li> <li>Regulación mecánica de la altura de trabajo, brazos laterales independientes a muelle</li> <li>Punta a muelle con reja de 26 cm</li> <li>Rodillo posterior dentado o a barras (especificar al ordenar) regulable en altura</li> <li>Protecciones de seguridad de acuerdo con la norma CE</li> </ul>	<ul style="list-style-type: none"> <li>Attelage 3 points Cat. II</li> <li>Système hydraulique alimenté par le tracteur</li> <li>Joystick multifonction</li> <li>Déplacement latéral hydraulique ouverture/fermeture</li> <li>2 bras porte-outils avec double palpeur</li> <li>Réglage mécanique de la hauteur de travail des bras latéraux indépendant des ancles a ressort</li> <li>Anclas a ressort avec socs de 26 cm</li> <li>Rouleau arrière denté ou avec barres (à préciser lors de la commande) réglable en hauteur</li> <li>Protections contre les accidents aux normes CE</li> </ul>

CTV	CULTIVATOR AND TOOL CARRIER
CTV	GRUBBER UND GERÄTETRÄGER
CTV	CULTIVADOR Y PORTAHERRAMIENTAS
CTV	CULTIVATEUR ET PORTE-OUTILS



ORIGINAL MADE IN ITALY

## VERSIONE PRO

PRO VERSION  
PROFIVERSION  
VERSIÓN PRO  
VERSION PRO

**UTENSILI vedere a pag. 216**

TOOLS see page 216

WERKZEUGE siehe Seite 216

HERRAMIENTAS ver página 216

OUTILS voir page 216

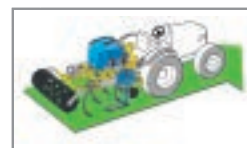

CTV PRO

# CTV PRO

L'immagine della macchina è indicativa. Gli utensili e gli accessori sono a richiesta. – The picture of the machine is indicative. Tools and accessories are on request.

MOD							
mod.	cod.	HP	nr	cm	cm	kg	euro
CTV 140 PRO	1003096	40 - 60	3 *	15	160×195×130	600	16.150,00
CTV 160 PRO	1003097	70 - 90	5 *	15	180×195×130	650	17.150,00
CTV 180 PRO	1003098	70 - 90	5 *	15	200×195×130	700	17.350,00
CTV 200 PRO	1003107	70 - 90	7 *	15	220×195×130	800	18.350,00
CTV 220 PRO	1003108	70 - 90	7 *	15	240×195×130	825	18.700,00
CTV 240 PRO	1003109	70 - 90	7 *	15	260×195×130	850	20.100,00

\*+2 ancore a molla con vomerini da 26 cm a richiesta \*+2 spring-loaded anchors with 26 cm ploughshares on request \*+2 Federbelastete Zinken mit 26 cm Pflugscharen auf Anfrage  
\*+2 punta a muelle con reja de 26 cm bajo pedido \*+2 anclas à ressort avec socs de 26 cm sur demande

\* Indicare il modello del rullo al momento dell'ordine

\* When ordering, the roller model must be indicated

\* Bei der Bestellung muss das Rollmodell angegeben werden

\* Indique el modelo del rodillo al realizar el pedido.

\* Indiquez le modèle du rouleau lors de la commande

Di serie	Standard equipment	Serienmässig	Estándar	De série
<ul style="list-style-type: none"> <li>Attacco a 3 punti Cat. II</li> <li>Impianto oleodinamico completo di serbatoio, sistema filtrante e scambiatore di calore</li> <li>Impianto idraulico alimentato dal trattore</li> <li>Joystick multifunzione</li> <li>Spostamento laterale idraulico apertura/chiusura</li> <li>2 bracci portattrezzi completi di doppio tastatore</li> <li>Regolazione meccanica altezza di lavoro bracci laterali indipendente dalle ancore a molla</li> <li>Ancore a molla con vomerini da 26 cm</li> <li>Rullo posteriore dentato o a gabbia (da specificare in fase d'ordine) regolabile in altezza</li> <li>Protezioni antinfortunistiche conformi alla normativa CE</li> </ul>	<ul style="list-style-type: none"> <li>3-point linkage cat. II</li> <li>Hydraulic system complete with tank, filter system and heat exchanger</li> <li>Tractor-powered hydraulics</li> <li>Multifunction Joystick</li> <li>Hydraulic side shift opening/closing</li> <li>2 tool-holding arms complete with double sensor</li> <li>Mechanical adjustment of working height of side arms independent of spring anchors</li> <li>Spring-loaded anchors with 26 cm ploughshares</li> <li>Rear toothed or cage roller (to be specified when ordering) adjustable in height</li> <li>Protective equipment as per EC safety rules</li> </ul>	<ul style="list-style-type: none"> <li>3-Punkt-Anbau Kat. II</li> <li>Hydraulisches System komplett mit Tank, Filtersystem und Wärmetauscher</li> <li>Traktorbetriebenes Hydrauliksystem</li> <li>Multifunktions-Joystick</li> <li>Hydraulische Seitenverschiebung öffnen/schließen</li> <li>2 Geräteträger-Arme komplett mit Doppeltaster</li> <li>Mechanische Einstellung der Arbeitshöhe der Seitenarme unabhängig von den Federankern</li> <li>Federbelastete Zinken mit 26 cm Pflugscharen</li> <li>Höhenverstellbare Gezähnte- oder Stabwalze (bei Bestellung anzugeben)</li> <li>Unfallschutz nach EU-Vorschriften</li> </ul>	<ul style="list-style-type: none"> <li>Enganche a 3 punto Cat. II</li> <li>Kit de centralita hidráulica completa de depósito, sistema filtrante e intercambiador de calor</li> <li>Sistema hidráulico alimentado por el tractor</li> <li>Joystick multifunción</li> <li>Desplazador lateral hidráulico apertura/cierre</li> <li>2 brazos porta herramienta completos de doble palpador</li> <li>Regulación mecánica de la altura de trabajo, brazos laterales independientes a muelle</li> <li>Punta a muelle con reja de 26 cm</li> <li>Rodillo posterior dentado o a barras (especificar al ordenar) regulable en altura</li> <li>Protecciones de seguridad de acuerdo con la norma CE</li> </ul>	<ul style="list-style-type: none"> <li>Attelage 3 points Cat. II</li> <li>Système hydraulique complet avec réservoir, système de filtrage et échangeur de chaleur</li> <li>Système hydraulique alimenté par le tracteur</li> <li>Joystick multifonction</li> <li>Déplacement latéral hydraulique ouverture/fermeture</li> <li>2 bras porte-outils avec double palpeur</li> <li>Réglage mécanique de la hauteur de travail des bras latéraux indépendant des ancles à ressort</li> <li>Anclas à ressort avec socs de 26 cm</li> <li>Rouleau arrière denté ou avec barres (à préciser lors de la commande) réglable en hauteur</li> <li>Protections contre les accidents aux normes CE</li> </ul>

## UTENSILI

WORKING TOOLS

WERKZEUGE

HERRAMIENTAS DE TRABAJO

OUTILS DE TRAVAIL

CTV

CTV PRO

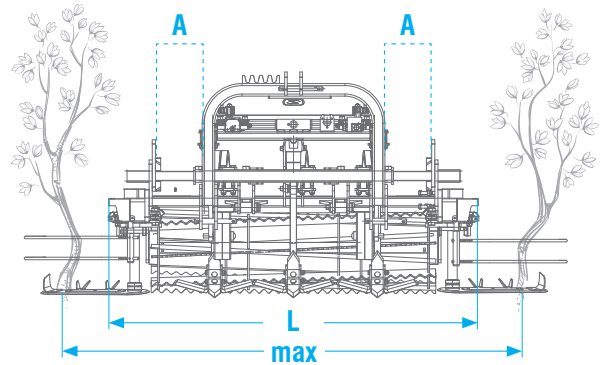
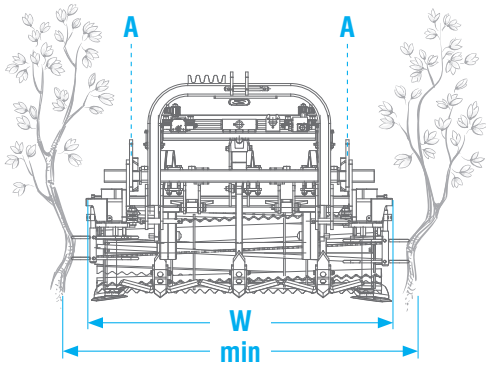

MOD	Macchina con braccetti e utensili chiusi Machine with closed arms and tools			
mod.	A cm	W cm	A cm	min. cm
CTV 140	--	146	--	180
CTV 160	--	166	--	200
CTV 180	--	186	--	220
CTV 200	--	206	--	240
CTV 220	--	226	--	260
CTV 240	--	246	--	280

MOD	Macchina con braccetti e utensili aperti Machine with open arms and tools			
mod.	A cm	L cm	A cm	max cm
CTV 140	15	176	15	230
CTV 160	15	196	15	250
CTV 180	15	216	15	270
CTV 200	15	236	15	290
CTV 220	15	256	15	310
CTV 240	15	276	15	330

### DSL 2

**Kit dischi scalzatori (2 dischi)**  
2 dischi in parallelo  
con spatola pulisci ceppo.  
Profondità di lavoro 30 cm

**Kit hydraulic discs (2 discs)**  
2 discs can be fitted in parallel  
with row cleaner blade.  
Working depth 30 cm

**Kit angetrieben Scheiben (2)**  
2 Scheiben können parallel mit  
Reihenreinigungsmesser montiert  
werden. Arbeitstiefe 30 cm

**Kit grada de discos (2 discos)**  
Posibilidad de montar 2 discos  
paralelos, con espátula limpia cepas.  
Profundidad de trabajo 30 cm

**Kit disques dechauseuse (2)**  
Possibilité de monter 2 disques en  
parallèle, avec spatule de nettoyage  
des cepes. Profondeur de travail 30 cm



cod.	cm	cm	l/min	kg	euro
2050868 DX	100	100	30	35	1.850,00
2050869 SX	115	115	30	35	1.850,00

### DSL 3

**Kit dischi scalzatori (3 dischi)**  
3 dischi in parallelo  
con spatola pulisci ceppo.  
Profondità di lavoro 30 cm

**Kit hydraulic discs (3 discs)**  
3 discs can be fitted in parallel  
with row cleaner blade.  
Working depth 30 cm

**Kit angetrieben Scheiben (3)**  
3 Scheiben können parallel mit  
Reihenreinigungsmesser montiert  
werden. Arbeitstiefe 30 cm

**Kit grada de discos (3 discos)**  
Posibilidad de montar 3 discos  
paralelos, con espátula limpia cepas.  
Profundidad de trabajo 30 cm

**Kit disques dechauseuse (3)**  
Possibilité de monter 3 disques en  
parallèle, avec spatule de nettoyage  
des cepes. Profondeur de travail 30 cm



cod.	cm	cm	l/min	kg	euro
2050694 DX	110	110	30	50	2.050,00
2050695 SX	115	115	30	50	2.050,00

CTV CTV PRO	CULTIVATOR AND TOOL CARRIER
CTV CTV PRO	GRUBBER UND GERÄTETRÄGER
CTV CTV PRO	CULTIVADOR Y PORTAHERRAMIENTAS
CTV CTV PRO	CULTIVATEUR ET PORTE-OUTILS



# UTENSILI

## WORKING TOOLS

## WERKZEUGE

## HERRAMIENTAS DE TRABAJO

## OUTILS DE TRAVAIL

**CTV**  
**CTV PRO**

CTV UTENSILI

### LSI

Kit lama scalzatrice con ala laterale ed esplosori	Kit blade weeder and side deflectors for Weeder blade	Kit Stockräumer und exploder für egge mit räumschar	Kit cuchilla interfilar y aletas para cuchilla binadora	Kit lame et sous-soleuses pour lame sarclouse		
	cod.	cm	cm	l/min	kg	euro
	2050681 DX	100	100 : 100	--	10	420,00
	2050682 SX	115	115 : 115	--	10	420,00

### ASI

Kit aratro scalzatore con spatola pulisci ceppo. Profondità di lavoro max 15 cm	Kit plough with row cleaner blade. Working depth max. 15 cm	Kit Pflug mit Säuberungschar. Max. Arbeitstiefe 15 cm	Kit arado desporcador con espátula limpia cepas. Profundidad de trabajo máx. 15 cm	Kit charrue avec spatule de nettoyage des ceps. Profondeur de travail max 15 cm		
	cod.	cm	cm	l/min	kg	euro
	2050683 DX	95	95 : 95	--	18	990,00
	2050684 SX	110	110 : 110	--	18	990,00

### RFI

Kit rotofresa idraulico 3 denti fresa Ø di lavoro 35 cm Paraterra regolabile	Kit hydraulic rotary tiller 3-Teeth tiller Working Ø 35 cm Soil & stone deflector adjustable	Kit Zinkenkreisel 3 Zähne Fräse Ø Arbeit 35 cm Erd- & Steinschieber verstellbar	Kit roto fresa hidraulica 3 dientes fresa Ø de trabajo 35 cm Cuchilla para-tierra ajustable	Kit roto-fraise hydraulique 3 dents fraise Ø de travail 35 cm Lame convoyeur de terre réglable		
	cod.	cm	cm	l/min	kg	euro
	2050688 DX	100	100 : 100	30	45	1.920,00
	2050689 SX	115	115 : 115	30	45	1.920,00

Kit inclinazione bracci portatezzi	Tilting kit for tool carrier arms	Kit Neigung für werkzeugträgerarme	Kit inclinacion brazo porta herramienta	Kit inclinasion bras avec porte outils		
Nota: sono necessari 4 innesti rapidi sulla trattoria Larghezza macchina + 8 cm	Note: 4 quick-release couplings are required on the tractor Width machine + 8 cm	Vermerken: Schnellkupplungen Werder am Traktor benötigt Maschinenbreite + 8 cm	Nota: se requieren 4 acoplamientos rápidos en el tractor Ancho de la máquina + 8 cm	Remarque: 4 raccords rapides sont nécessaires sur le tracteur Largeur de la machine + 8 cm		
	cod.	cm	cm	l/min	kg	euro
 +15° -15°	2050833	100	100 : 100	10	25	1.250,00
		115	115 : 115			

## UTENSILI

WORKING TOOLS







WERKZEUGE





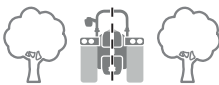

HERRAMIENTAS DE TRABAJO





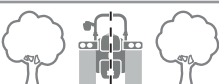

OUTILS DE TRAVAIL







CTV

CTV PRO

Kit ancora aprisolco	Kit anchor fixed	Kit Zinken Fest	Kit punta abre surco	Kit ancre	
					
					
cod.	cm	cm	l/min	kg	euro
2050687	90 105	90 : 90 105 : 105	--	8	140,00

Kit disco aprisolco	Kit disc fixed	Kit Scheibenflug fest	Disco de corte	Kit disque	
					
					
cod.	cm	cm	l/min	kg	euro
2050690 DX	90	90 : 90	--	8	460,00
2050691 SX	105	105 : 105	--	8	460,00

Ancore a molla con vomerini da 26 cm	Spring-loaded anchors with 26 cm ploughshares	Federbelastete Zinken mit 26 cm Pflugscharen	Punta a muelle con reja de 26 cm	Ancre à ressort avec socs de 26 cm	
					
					
cod.	cm	cm	l/min	kg	euro
2050773 DX	25	15	--	17	380,00
2050774 SX	25	15	--	17	380,00

Ancora a molla Dente a "scarpetta" e aletta laterale	Spring-loaded anchor Plowshare shoes and side flap	Federbelastete Zinken Pflugschardschuhe und Seitenklappe	Punta a muelle Kit desporcador con alas laterales	Ancre à ressort Kit ancre avec ailes latérales	
					
					
cod.	cm	cm	l/min	kg	euro
2050771 DX	39	22	--	22	560,00
2050772 SX	39	22	--	22	560,00



CTV CTV PRO	CULTIVATOR AND TOOL CARRIER
CTV CTV PRO	GRUBBER UND GERÄTETRÄGER
CTV CTV PRO	CULTIVADOR Y PORTAHERRAMIENTAS
CTV CTV PRO	CULTIVATEUR ET PORTE-OUTILS



# UTENSILI

WORKING TOOLS  
WERKZEUGE  
HERRAMIENTAS DE TRABAJO  
OUTILS DE TRAVAIL



CTV UTENSILI

Ruote di profondità regolabili in altezza	Height-adjustable depth wheels	Tiefenräder mit Führung	Ruedas de profundidad con regulación en altura	Roues de profondeur avec guide réglables en hauteur		
	cod.	cm	cm	l/min	kg	€
	2050780	--	--	--	6	530,00

Rullo a gabbia	Cage roller	Stabwalze	Rodillo de jaula	Rouleau barre	
	MOD				€
	mod.	cod.	cm	kg	euro
	CTV 140 *	3232543	41,5	52	1.290,00
	CTV 160 *	3232529	41,5	55	1.360,00
	CTV 180 *	3232544	41,5	63	1.440,00
	CTV 200 *	3232654	41,5	68	1.510,00
	CTV 220 *	3232655	41,5	72	1.570,00
	CTV 240 *	3232656	41,5	80	1.630,00

Rullo dentato	Toothed roller	Zahnwalze	Rodillo dentado	Rouleau denté	
	MOD				€
	mod.	cod.	cm	kg	euro
	CTV 140 *	3232602	44	68	1.290,00
	CTV 160 *	3232603	44	73	1.360,00
	CTV 180 *	3232604	44	78	1.440,00
	CTV 200 *	3232643	44	82	1.510,00
	CTV 220 *	3232644	44	88	1.570,00
	CTV 240 *	3232645	44	98	1.630,00

\* Indicare il modello del rullo al momento dell'ordine

\* When ordering, the roller model must be indicated

\* Bei der Bestellung muss das Rollmodell angegeben werden

\* Indique el modelo del rodillo al realizar el pedido.

\* Indiquez le modèle du rouleau lors de la commande

### Impiego

Il disco interfilare a molla IT-M viene applicato alle nostre trincia e permette il taglio dell'erba nell'interceppo senza l'uso di tastatori. Il disco interfilare, grazie ad una molla di richiamo, quando entra a contatto con il fusto della pianta rientra senza causare danni alla stessa.

### Use

The IT-M spring-loaded inter-row disc is fitted to our mulchers and allows the grass to be cut in the inter-row without the use of sensors. The inter-row disc, thanks to a return spring, returns when it comes into contact with the plant stem without causing damage to the plant.

### Verwendung

Die federbelastete IT-M Zwischenreihen-Scheibe ist an unseren Mulchern angebracht und ermöglicht das Schneiden des Grases in der Zwischenreihe ohne den Einsatz von Sensoren. Die Zwischenreihenscheibe kehrt dank einer Rückholfeder zurück, wenn sie mit dem Pflanzenstamm in Berührung kommt, ohne die Pflanze zu beschädigen.

### Uso

El disco interfilare IT-M accionado mediante muelle, se puede aplicar a la gama de desbrozadoras/trituradoras no reversibles disponibles, permitiendo el corte de la broza entre los centros de las plantas. El disco interfilare, gracias a su muelle regulable en tensión, al entrar en contacto con el tronco de la planta, se retira del centro de la misma, cortando la broza en torno a ella y no efectúa daños en ella.

### Utilisation

Le disque interligne IT-M avec retour à ressort monté sur nos broyeurs permet de couper l'herbe entre les interceps sans l'utilisation de le palpeur hydraulique. Le disque interligne, grâce à sa ressort speciale, pendant le contact avec la plante ne cause aucun dégât à la même.









Sistema BREVETTATO di fissaggio del filo  
Wire fixing PATENTED system  
PATENTIERTES System zur Drahtbefestigung  
Sistema PATENTADO de fijación de hilo  
Système BREVETÉ de fixation du fil

#### Versione con lame







Version with blades - Version mit Messern  
Versión con cuchillas - Version avec lames

#### Versione con filo

Wire version - Version mit Faden  
Versión con hilo - Version avec fil

Ø 60						€			€
mod.	cm	kg	l/min	cod.	nr	euro	cod.	nr	euro
IT-M / TFZ	60	90	35	1003219	2	2.950,00	1003811	4	2.950,00
IT-M / TMU	60	90	35	1003220	2	2.950,00	1003800	4	2.950,00
IT-M / LFG	60	90	35	1003221	2	2.950,00	1003801	4	2.950,00
IT-M / TFB	60	90	35	1003222	2	2.950,00	1003802	4	2.950,00
IT-M / TFA / TFO	60	90	35	1003223	2	2.950,00	1003803	4	2.950,00
IT-M / TRE-PRO	60	90	35	1003224	2	2.950,00	1003804	4	2.950,00

Ø 80						€			€
mod.	cm	kg	l/min	cod.	nr	euro	cod.	nr	euro
IT-M / TFZ	80	110	35	1003225	2	3.150,00	1003805	4	3.150,00
IT-M / TMU	80	110	35	1003226	2	3.150,00	1003806	4	3.150,00
IT-M / LFG	80	110	35	1003227	2	3.150,00	1003807	4	3.150,00
IT-M / TFB	80	110	35	1003228	2	3.150,00	1003808	4	3.150,00
IT-M / TFA / TFO	80	110	35	1003229	2	3.150,00	1003809	4	3.150,00
IT-M / TRE-PRO	80	110	35	1003230	2	3.150,00	1003810	4	3.150,00

<b>IT-M</b>	<b>INTER-ROW DISC FOR MULCHER WITH RETURN SPRING</b>
<b>IT-M</b>	<b>SCHWENKSCHLEIBE FÜR MULCHER FEDERBELASTET</b>
<b>IT-M</b>	<b>CABEZAL INTERFILAR CON RETORNO A MUELLE</b>
<b>IT-M</b>	<b>TÊTE INTER-RANGS AVEC RETOUR AU RESSORT</b>

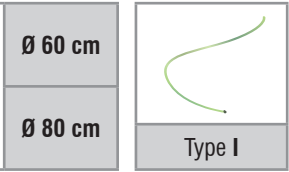
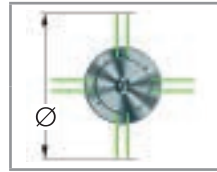
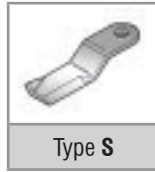
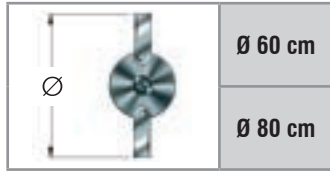

Il disco interfilare è montato su un sistema di parallele che lo rende flottante, consentendogli di adattarsi ad eventuali irregolarità del terreno.

È inoltre possibile regolare l'inclinazione del disco interfilare, così da poter lavorare anche su dirupi o scoli.

L'attrezzo richiede una coppia di prese idrauliche al trattore (il trattore deve essere dotato di scarico libero) e minimo 35 lt/min di olio dal trattore.

The inter-row cutter disk is mounted on a parallel guide system that leaves it float and follow the surface of uneven ground. The angle of the inter-row cutter disk can be adjusted to cut the edges of embankments and drainage channels.

The implement requires a pair of hydraulic connections to the tractor (the tractor must be equipped with free drainage) and a minimum of 35 l/min of oil from the tractor.

Die Mähscheibe ist auf einem System von Parallelen montiert, das sie schwimmend macht, so dass sie sich an alle Unebenheiten des Bodens anpassen kann. Es ist auch möglich, die Neigung der Scheibe einzustellen.

Das Gerät benötigt ein Paar hydraulische Anschlüsse zum Traktor (der Traktor muss mit freiem Abfluss ausgestattet sein) und eine Mindestleistung von 35 l/min vom Traktor.

El disco interlíneas está montado en un sistema de paralelas y es flotante para permitirle seguir las irregularidades del terreno. También es posible regular la inclinación del disco interlíneas, para poder trabajar en canales y pendientes. El interfiliar va acoplado al hidráulico del tractor, por lo tanto se requieren un distribuidor doble y con la descarga directa al tanque, la capacidad mínima de aceite necesaria para el accionamiento del interfiliar es de 35 litros.

Le disque inter-rangs est monté sur un système de guidages parallèles qui le rend flottant, en lui permettant de s'adapter aux éventuelles irrégularités du sol. Il est possible également de régler l'inclinaison du disque inter-rangs de manière à pouvoir travailler aussi sur les pentes raides ou les fossés. L'outil exige deux prises hydrauliques côté tracteur (le tracteur doit avoir le décharge libre) et au moins 35 lt/min d'huile de le circuit du tracteur.

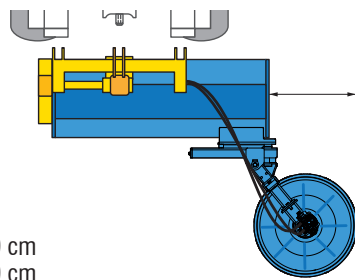
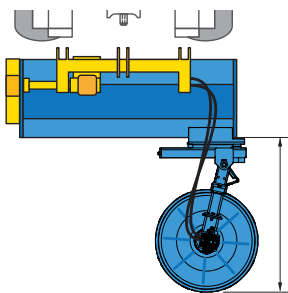

IT Ø 60 = 55 cm  
IT Ø 80 = 77 cm

IT Ø 60 = 100 cm  
IT Ø 80 = 120 cm

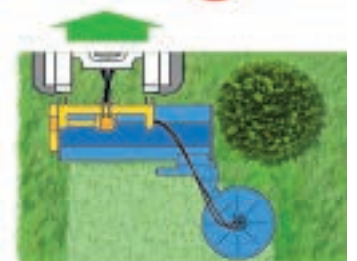
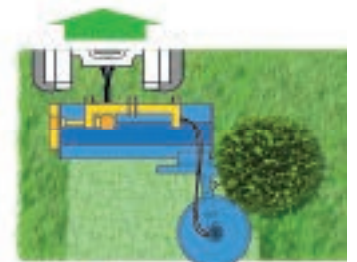
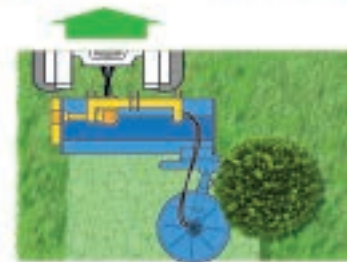
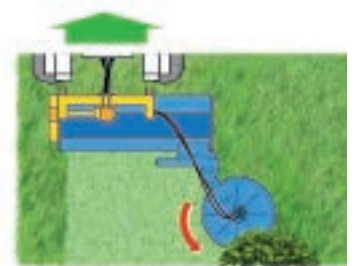

## MOVIMENTO 1 / MOVEMENT 1

Inclinazione testata  
Inter-row disc inclination  
Zwischenreihenscheibe neigung  
Inclinación de disco entre hileras  
Disque inter-rangée



## MOVIMENTO 2 / MOVEMENT 2

Regolazione meccanica altezza asse  
Arm's height mechanical adjustment  
Mechanische Einstellung Arbeitsposition  
Regulación de altura  
Réglage hauteur axe















cod.	A richiesta	On request	Auf Anfrage	Opcionales	Sur demande	€
2051250	Kit trasformazione da lame a filo per IT-M Ø60/Ø80	Conversion kit from blades to wire for IT-M Ø60/Ø80	Umrüstszatz von Klingen auf Draht für IT-M Ø60/Ø80	Kit de conversión de cuchillas a hilo para IT-M Ø60/Ø80	Kit de conversion de lames à fil pour IT-M Ø60/Ø80	590,00

cod.	Ricambi	Spare parts	Ersatzteile	Recambios	Pièces de rechange
5421033	Motore testata	Inter-row motor	Zwischenreihen-Vorsatzgerät Motor	Motor de cabezal	Moteur tete
5350165	Lama	Blade	Messer	Cuchilla	Couteau
5335070	Molla rientro testata	Return spring	Rückholfeder	Muelle de retorno	Ressort de rappel

Impiego	Use	Verwendung	Uso	Utilisation
La testata interfilare IT è un accessorio applicabile alla trincia ed è utile per la pulizia attorno al fusto delle piante e dell'interfila, senza provocare danni alla corteccia.	The IT inter-row head accessory fits on the mulcher and cleans around the stems of crop plants and in alleyways without damaging the crop plants themselves.	Die IT Mähsscheibe passt auf den Mulcher und ist so konstruiert, dass sie das Gras um die Bäume herum mäht, ohne die Ernte zu beschädigen.	El cabezal interlíneas IT es un accesorio que se monta en la trituradora y que sirve para limpiar alrededor de las plantas y las interlíneas sin dañar la corteza.	La tête inter-rangs IT est un accessoire applicable au broyeur, utile pour le nettoyage autour du tronc des plants et dans les espaces inter-rangs, sans endommager l'écorce.



Sistema BREVETTATO di fissaggio del filo  
Wire fixing PATENTED system  
PATENTIERTES System zur Drahtbefestigung  
Sistema PATENTADO de fijación de hilo  
Système BREVETÉ de fixation du fil

Versione con lame						Versione con filo			
Version with blades - Version mit Messern						Wire version - Version mit Faden			
Versión con cuchillas - Version avec lames						Versión con hilo - Version avec fil			
Ø 50					€			€	
mod.	cm	kg	cod.	nr	euro	cod.	nr	euro	
<b>IT / TFZ</b>	50	120	1002546	2	<b>5.470,00</b>	1003207	4	<b>5.470,00</b>	
<b>IT / TMU</b>	50	120	1002563	2	<b>5.470,00</b>	1003799	4	<b>5.470,00</b>	
<b>IT / LFG</b>	50	120	1002594	2	<b>5.470,00</b>	1003208	4	<b>5.470,00</b>	
<b>IT / TFB</b>	50	120	1002625	2	<b>5.470,00</b>	1003209	4	<b>5.470,00</b>	
<b>IT / TFA / TFO</b>	50	120	1002821	2	<b>5.470,00</b>	1003210	4	<b>5.470,00</b>	
<b>IT / TRE-PRO</b>	50	120	1002951	2	<b>5.690,00</b>	1003211	4	<b>5.690,00</b>	
Ø 70					€			€	
mod.	cm	kg	cod.	nr	euro	cod.	nr	euro	
<b>IT / TFZ</b>	70	135	1002909	2	<b>5.920,00</b>	1003212	4	<b>5.920,00</b>	
<b>IT / TMU</b>	70	135	1002911	2	<b>5.920,00</b>	1003213	4	<b>5.920,00</b>	
<b>IT / LFG</b>	70	135	1002913	2	<b>5.920,00</b>	1003214	4	<b>5.920,00</b>	
<b>IT / TFB</b>	70	135	1002914	2	<b>5.920,00</b>	1003215	4	<b>5.920,00</b>	
<b>IT / TFA / TFO</b>	70	135	1002915	2	<b>5.920,00</b>	1003216	4	<b>5.920,00</b>	
<b>IT / TRE-PRO</b>	70	135	1002952	2	<b>6.150,00</b>	1003101	4	<b>6.150,00</b>	

Di serie	Standard equipment	Serienmässig	Estándar	De série
<ul style="list-style-type: none"> <li>Distributore di esclusione della testata interfilare</li> <li>Distributore accensione del gruppo lame</li> <li>Serbatoio di olio da 40 litri</li> <li>Kit attacco pompa</li> <li>Protezioni antinfortunistiche conformi alla normativa CE</li> </ul>	<ul style="list-style-type: none"> <li>Inter-row head retraction distributor</li> <li>Cutter drive distributor</li> <li>40 liters hydraulic fluid tank</li> <li>Pump drive kit</li> <li>Protective equipment as per EC safety rules</li> </ul>	<ul style="list-style-type: none"> <li>Ausschlussverteilergetriebe des interfilaren Kopfs</li> <li>Verteilergetriebe und Einschalten Schnittblattgruppe</li> <li>40 l - Ölbehälter</li> <li>Pumpenanschluss</li> <li>Unfallschutz nach EU-Vorschriften</li> </ul>	<ul style="list-style-type: none"> <li>Distribuidor de desactivación del cabezal interlíneas</li> <li>Distribuidor y encendido del grupo de cuchillas</li> <li>Depósito de aceite de 40 litros</li> <li>Kit de conexión de bomba</li> <li>Protecciones de seguridad de acuerdo con la norma CE</li> </ul>	<ul style="list-style-type: none"> <li>Distributeur d'exclusion de la tête inter-rangs</li> <li>Distributeur et allumage du groupe des lames</li> <li>Réservoir d'huile de 40 litres</li> <li>Kit de raccord pompe</li> <li>Protections contre les accidents aux normes CE</li> </ul>

IT	INTER-ROW DISC FOR MULCHER
IT	HYDRAULISCHE SCHWENKSCHLEIBE FÜR MULCHER
IT	CABEZAL INTERFILAR CON PALPADOR HIDRÁULICO
IT	TÊTE INTER-RANGS AVEC PALPEUR HYDRAULIQUE



Il disco interfilare è montato su un sistema di parallele che lo rende flottante, consentendogli di adattarsi ad eventuali irregolarità del terreno. È, inoltre, possibile regolare l'inclinazione del disco interfilare, così da poter lavorare anche su dirupi o scoli.

The inter-row cutter disk is mounted on a parallel guide system that leaves it float and follow the surface of uneven ground. The angle of the inter-row cutter disk can be adjusted to cut the edges of embankments and drainage channels.

Die Mähscheibe ist auf einem System von Parallelen montiert, das sie schwimmend macht, so dass sie sich an alle Unebenheiten des Bodens anpassen kann. Es ist auch möglich, die Neigung der Scheibe einzustellen.

El disco interlíneas está montado en un sistema de paralelas y es flotante para permitirle seguir las irregularidades del terreno. También es posible regular la inclinación del disco interlíneas, para poder trabajar en canales y pendientes.

Le disque inter-rangs est monté sur un système de guidages parallèles qui le rend flottant, en lui permettant de s'adapter aux éventuelles irrégularités du sol. Il est possible également de régler l'inclinaison du disque inter-rangs de manière à pouvoir travailler aussi sur les pentes raides ou les fossés.

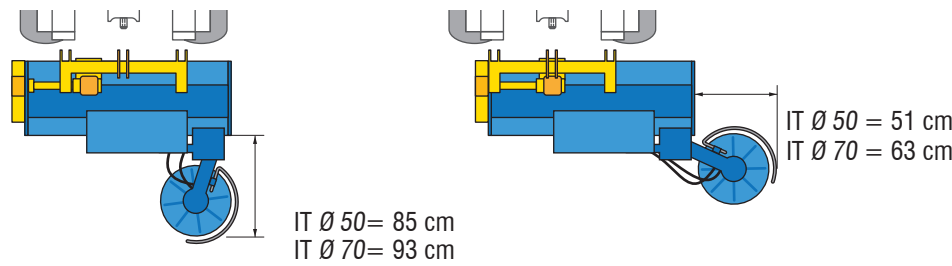
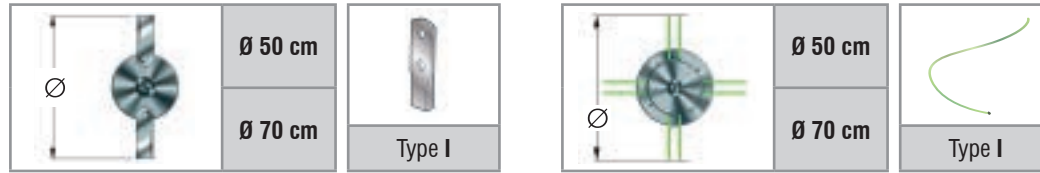

### MOVIMENTO 1 / MOVEMENT 1

Inclinazione testata  
Inter-row disc inclination  
Zwischenreihenscheibe neigung  
Inclinación de disco entre hileras  
Disque inter-rangée



### MOVIMENTO 2 / MOVEMENT 2

Regolazione meccanica altezza asse  
Arm's height mechanical adjustment  
Mechanische Einstellung Arbeitsposition  
Regulación de altura  
Réglage hauteur axe

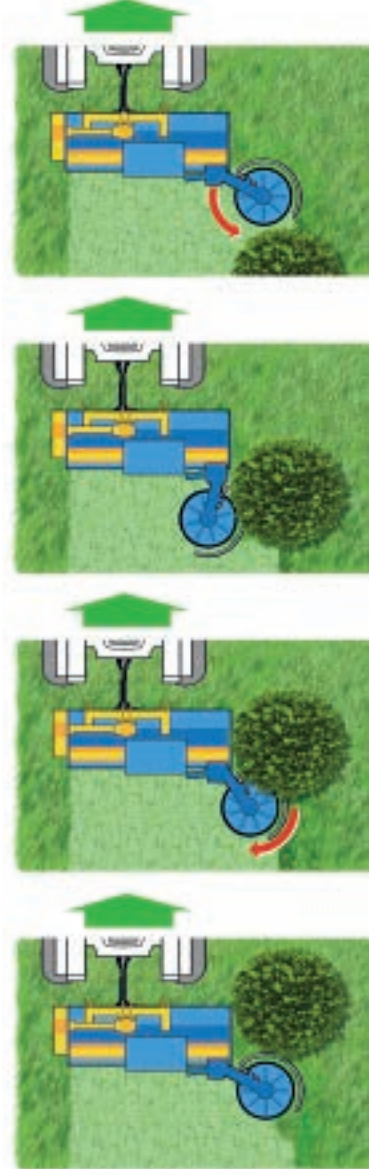

cod.	A richiesta	On request	Auf Anfrage	Opcionales	Sur demande	€
5444295	Kit richiamo testata meccanico direttamente dal trattore	Mechanical head recall kit directly from the tractor	Mechanischer Kopf-Rücklaufsatz direkt vom Traktor	Kit de accionamiento del cabezal directamente del tractor	Kit arret tete mecanique directement de le tracteur	325,00
2051251	Kit trasformazione da lame a filo per IT Ø50/Ø70	Conversion kit from blades to wire for IT Ø50 / Ø70	Umrüstsatz von Klingen auf Draht für IT Ø50 / Ø70	Kit de conversión de cuchillas a hilo para IT Ø50 / Ø70	Kit de conversion de lames à fil pour IT Ø50 / Ø70	590,00

cod.	Ricambi	Spare parts	Ersatzteile	Recambios	Pièces de rechange
5110025	Semigiunto	Half coupling	Kupplungshälfte	Mitad de acoplamiento	Demi-accouplement
5421016	Pompa doppia	Double pump	Doppelpumpe	Bomba doble	Pompe double
5421015	Motore testata (Ø 70)	Inter-row motor (Ø 70)	Zwischenreihen-Vorsatzgerät Mot. (Ø 70)	Motor de cabezal (Ø 70)	Moteur tete (Ø 70)
5421019	Motore testata (Ø 50)	Inter-row motor (Ø 50)	Zwischenreihen-Vorsatzgerät Mot. (Ø 50)	Motor de cabezal (Ø 50)	Moteur tete (Ø 50)
5314009	Filtro	Filter	Filter	Filtro	Filtre
5350117	Lama	Blade	Messer	Cuchilla	Couteau
5335027	Tastatore	Hyd. Finger	Schwenscheibe	Palpador	Palpeur

Impiego	Use	Verwendung	Uso	Utilisation
---------	-----	------------	-----	-------------

La testata interfilare IT-PRO è un accessorio applicabile alla trincia ed è utile per la pulizia attorno al fusto delle piante e dell'interfila, senza provocare danni alla corteccia.

The IT-PRO inter-row head accessory fits on the mulcher and cleans around the stems of crop plants and in alleyways without damaging the crop plants themselves.

Die IT-PRO Mähsscheibe passt auf den Mulcher und ist so konstruiert, dass sie das Gras um die Bäume herum mäht, ohne die Ernte zu beschädigen.

El cabezal interlíneas IT-PRO es un accesorio que se monta en la trituradora y que sirve para limpiar alrededor de las plantas y las interlíneas sin dañar la corteza.

La tête inter-rangs IT-PRO est un accessoire applicable au broyeur, utile pour le nettoyage autour du tronc des plants et dans les espaces inter-rangs, sans endommager l'écorce.

### Di serie

- Serbatoio olio indipendente 40 lt
- Doppio sistema filtrante
- Kit attacco pompa
- Scambiatore di calore
- Joystick multifunzione
- Regolazione inclinazione, apertura/chiusura testata, on/off rotore, tutto tramite joystick
- Protezioni antinfortunistiche conformi alla normativa CE

### Standard equipment

- Independent oil tank 40 lt
- Double filtering system
- Pump connection kit
- Heat exchanger
- Multifunction Joystick
- Tilt adjustment, opening/closing head, on/off rotor, all with joystick
- Protective equipment as per EC safety rules

### Estándar

- Deposito de aceite independiente de 40 litros
- Sistema doble filtrante
- Kit acople bomba
- Intercambiador de calor
- Joystick multifunción
- Ajuste de inclinación, apertura/cierre de la cabeza, encendido/apagado rotor, todo con joystick
- Protecciones de seguridad de acuerdo con la norma CE

### Serienmässig

- Unabhängiger Öltank 40 lt
- Doppeltes Filtersystem
- Pumpenanschluss-Satz
- Wärmetauscher
- Multifunktions-Joystick
- Neigungsverstellung, Öffnungs-/Schließkopf, Ein/Aus-Rotor, alle mit Joystick
- Unfallschutz nach EU-Vorschriften

### De série

- Réservoir d'huile indépendant de 40 l
- Double système de filtration
- Kit connexion pompe
- Echangeur de chaleur
- Joystick multifonction
- Réglage de l'inclinaison, ouverture/fermeture de la tête, marche/arrêt rotor, tout avec joystick
- Protections contre les accidents aux normes CE



**Sistema BREVETTATO di fissaggio del filo**  
**Wire fixing PATENTED system**  
**PATENTIERTES System zur Drahtbefestigung**  
**Sistema PATENTADO de fijación de hilo**  
**Système BREVETÉ de fixation du fil**

**Versione con lame**  
 Version with blades - Version mit Messern  
 Versión con cuchillas - Version avec lames

**Versione con filo**  
 Wire version - Version mit Faden  
 Versión con hilo - Version avec fil

Ø 50						Ø 70					
mod.	cm	kg	cod.	nr	euro	mod.	cm	kg	cod.	nr	euro
IT-PRO / TFZ	50	130	1003183	2	7.130,00	IT-PRO / TFZ	70	145	1003189	2	7.340,00
IT-PRO / TMU	50	130	1003184	2	7.130,00	IT-PRO / TMU	70	145	1003190	2	7.340,00
IT-PRO / LFG	50	130	1003185	2	7.130,00	IT-PRO / LFG	70	145	1003191	2	7.340,00
IT-PRO / TFB	50	130	1003186	2	7.130,00	IT-PRO / TFB	70	145	1003192	2	7.340,00
IT-PRO / TFA / TFO	50	130	1003187	2	7.130,00	IT-PRO / TFA / TFO	70	145	1003193	2	7.340,00
IT-PRO / TRE-PRO	50	130	1003188	2	7.130,00	IT-PRO / TRE-PRO	70	145	1003194	2	7.340,00

<b>IT-PRO</b>	INTER-ROW DISC FOR MULCHER WITH HYDRAULIC PROBE with JOYSTICK
<b>IT-PRO</b>	HYDRAULISCHE SCHWENKSCHIBE FÜR MULCHER mit JOYSTICK
<b>IT-PRO</b>	CABEZAL INTERFILAR CON PALPADOR HIDRÁULICO con JOYSTICK
<b>IT-PRO</b>	TÊTE INTER-RANGS AVEC PALPEUR HYDRAULIQUE avec JOYSTICK

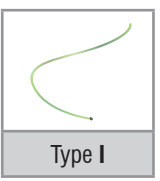
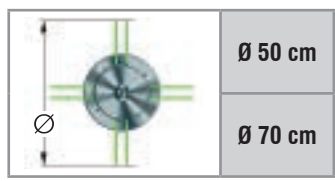
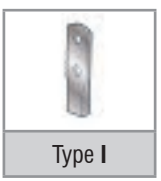
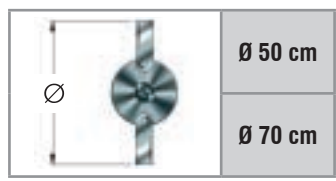

Il disco interfilare è montato su un sistema di parallele che lo rende flottante, consentendogli di adattarsi ad eventuali irregolarità del terreno. È, inoltre, possibile regolare l'inclinazione del disco interfilare, così da poter lavorare anche su dirupi o scoli.

The inter-row cutter disk is mounted on a parallel guide system that leaves it float and follow the surface of uneven ground. The angle of the inter-row cutter disk can be adjusted to cut the edges of embankments and drainage channels.

Die Mähscheibe ist auf einem System von Parallelen montiert, das sie schwimmend macht, so dass sie sich an alle Unebenheiten des Bodens anpassen kann. Es ist auch möglich, die Neigung der Scheibe einzustellen.

El disco interlíneas está montado en un sistema de paralelas y es flotante para permitirle seguir las irregularidades del terreno. También es posible regular la inclinación del disco interlíneas, para poder trabajar en canales y pendientes.

Le disque inter-rangs est monté sur un système de guidages parallèles qui le rend flottant, en lui permettant de s'adapter aux éventuelles irrégularités du sol. Il est possible également de régler l'inclinaison du disque inter-rangs de manière à pouvoir travailler aussi sur les pentes raides ou les fossés.

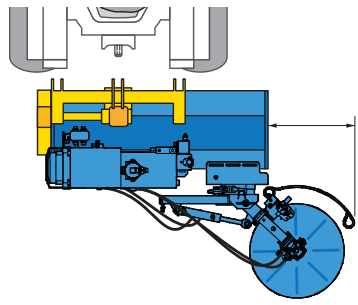
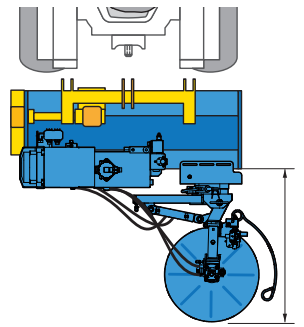

**MOVIMENTO 1 / MOVEMENT 1**

- Inclinazione testata (con joystick multifunzione)
- Inter-row disc inclination (with multifunction joystick)
- Zwischenreihenscheibe neigung (mit Multifunktions-Joystick)
- Inclinación de disco entre hileras (con joystick multifunción)
- Disque inter-rangée (avec joystick multifonction)



**MOVIMENTO 2 / MOVEMENT 2**

- Regolazione meccanica altezza asse
- Arm's height mechanical adjustment
- Mechanische Einstellung Arbeitsposition
- Regulación de altura
- Réglage hauteur axe

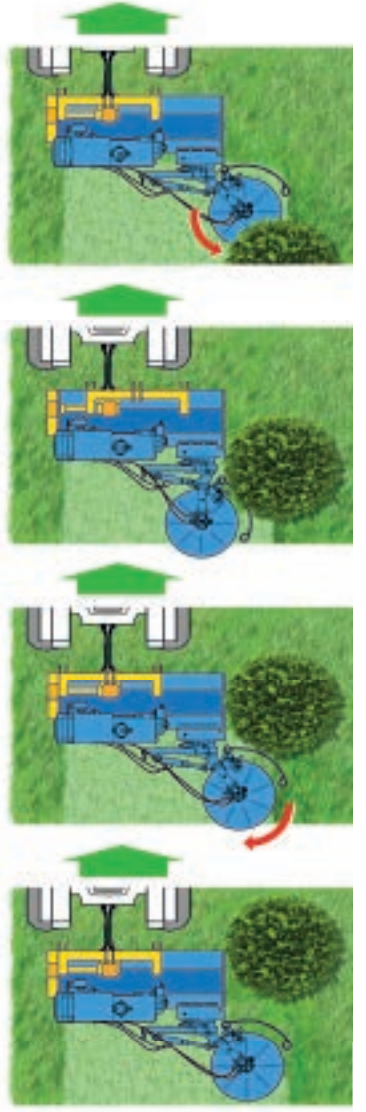

cod.	A richiesta	On request	Auf Anfrage	Opcionales	Sur demande	€
2051251	Kit trasformazione da lame a filo per IT Ø50/Ø70	Conversion kit from blades to wire for IT Ø50 / Ø70	Umrüstsatz von Klingen auf Draht für IT Ø50 / Ø70	Kit de conversión de cuchillas a hilo para IT Ø50 / Ø70	Kit de conversion de lames à fil pour IT Ø50 / Ø70	590,00
cod.	Ricambi	Spare parts	Ersatzteile	Recambios	Pièces de rechange	
5110025	Semigiunto	Half coupling	Kupplungshälfte	Mitad de acoplamiento	Demi-accouplement	
5421046	Pompa singola	Single pump	Einzelpumpe	Bomba simple	Pompe simple	
5421019	Motore testata	Inter-row motor	Zwischenreihen-Vorsatzgerät	Motor de cabezal	Moteur tete	
5314020	Filtro	Filter	Filter	Filtro	Filtre	
5350117	Lama	Blade	Messer	Cuchilla	Couteau	
5450065	Bobina filo 155 mt Ø 6 mm	Wire 155 mt Ø 6 mm	Garnrolle 155 mt Ø 6 mm	Hilo 155 mt Ø 6 mm	Bobine de fil 155 mt Ø 6 mm	
5335027	Tastatore	Hyd. Finger	Schwenscheibe	Palpador	Palpeur	

IT-PRO

## VERSIONE SINGOLA







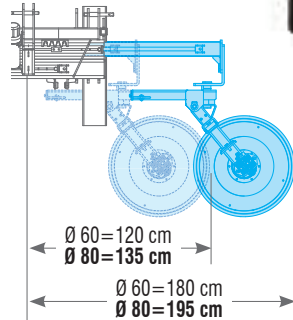
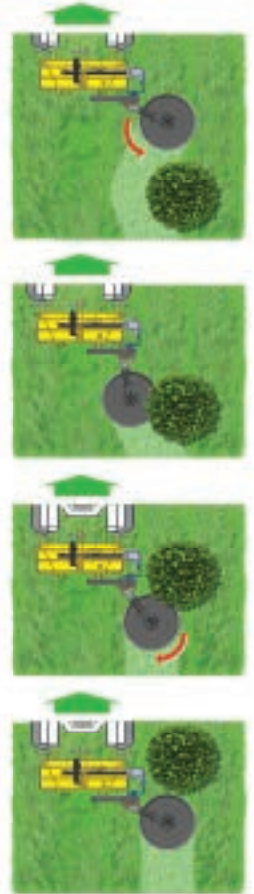

SINGLE VERSION

EINZELVERSION







VERSIÓN INDIVIDUAL

VERSION SIMPLE



MOD								
mod.	cod.	HP	l/min	$\varnothing$ cm	nr	cm	kg	euro
<b>ITX <math>\varnothing 60</math> singola</b>	1003150	30 - 100	35	60	2	170×145×115	295	<b>5.400,00</b>
<b>ITX <math>\varnothing 80</math> singola</b>	1003151	30 - 100	35	80	2	185×160×115	310	<b>5.850,00</b>

Di serie	Standard equipment	Serienmässig	Estándar	De série
<ul style="list-style-type: none"> <li>Attacco a 3 punti Cat. I-II</li> <li>Regolazione idraulica apertura/chiusura</li> <li>Testata flottante per seguire l'andamento del terreno</li> <li>Richiamo a molla della testata</li> <li>Regolazione rigidità molla di richiamo</li> <li>Protezioni antinfortunistiche conformi alla normativa CE</li> </ul>	<ul style="list-style-type: none"> <li>3-point linkage cat. I-II</li> <li>Hydraulic opening/closing adjustment</li> <li>Floating head to follow the ground surface</li> <li>Spring-loaded head return</li> <li>Return spring tension adjustment</li> <li>Safety protections to CE standards</li> </ul>	<ul style="list-style-type: none"> <li>3-Punkt-Anbau Kat. I-II</li> <li>Hydraulischer Verstellung Öffnen/Schließen</li> <li>Pendelnder Kopf, um der Bodenoberfläche zu folgen</li> <li>Federbelasteter Kopfrücklauf</li> <li>Einstellung der Rückstellfederspannung</li> <li>Sicherheitseinrichtungen nach CE-Normen</li> </ul>	<ul style="list-style-type: none"> <li>Enganche a 3 punto Cat. I-II</li> <li>Regulación hidráulica apertura/cierre</li> <li>Cabeza flotante para seguir la duna del suelo</li> <li>Cabezal interfilare con retorno a muelle</li> <li>Ajuste de rigidez del retorno a muelle</li> <li>Protecciones de seguridad de acuerdo con la norma CE</li> </ul>	<ul style="list-style-type: none"> <li>Attelage 3 points Cat. I-II</li> <li>Réglage hydraulique ouverture/fermeture</li> <li>Disque satellite flottant adaptable au cours de le terrains</li> <li>Retour à ressort disque satellite</li> <li>Reglage rigidité du ressort</li> <li>Protections contre les accidents aux normes CE</li> </ul>

A richiesta	On request	Auf Anfrage	Opcionales	Sur demande
Kit attacco frontale per ITX versione singola	Kit front attachment for ITX single version	Frontanbaukit für ITX Einzelausführung	Kit acople frontal para ITX versión individual	Kit de connexion avant pour ITX version simple
				
	cod.	cat.	cm	kg
	2050925	II	-	27
				
				<b>680,00</b>



ITX	INTER-ROW DISC WITH RETURN SPRING
ITX	SCHWENKSCHIBE FEDERBELASTET
ITX	CABEZAL INTERFILAR CON RETORNO A MUELLE
ITX	TÊTE INTER-RANGS AVEC RETOUR AU RESSORT



ORIGINAL MADE IN ITALY

## VERSIONE DOPPIA

DOUBLE VERSION

DOPPELTE VERSION

VERSIÓN DOBLE

VERSION DOUBLE

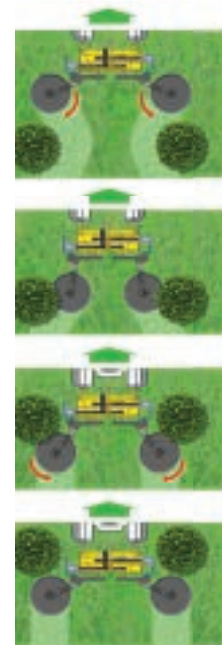

ITX

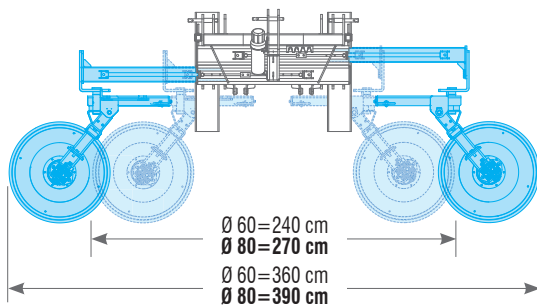
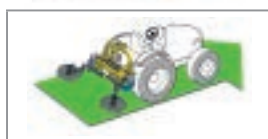



MOD								
mod.	cod.	HP	l/min	$\varnothing \text{ cm}$	nr	cm	kg	euro
<b>ITX <math>\varnothing 60</math> doppia</b>	1003136	30 - 100	70	60	2	238×145×115	390	<b>8.650,00</b>
<b>ITX <math>\varnothing 80</math> doppia</b>	1003137	30 - 100	70	80	2	270×160×115	415	<b>9.100,00</b>

Di serie	Standard equipment	Serienmässig	Estándar	De série
<ul style="list-style-type: none"> <li>• Attacco a 3 punti Cat. I-II</li> <li>• Regolazione idraulica apertura/chiusura</li> <li>• Testata flottante per seguire l'andamento del terreno</li> <li>• Richiamo a molla della testata</li> <li>• Regolazione rigidità molla di richiamo</li> <li>• Protezioni antinfortunistiche conformi alla normativa CE</li> </ul>	<ul style="list-style-type: none"> <li>• 3-point linkage cat. I-II</li> <li>• Hydraulic opening/closing adjustment</li> <li>• Floating head to follow the ground surface</li> <li>• Spring-loaded head return</li> <li>• Return spring tension adjustment</li> <li>• Safety protections to CE standards</li> </ul>	<ul style="list-style-type: none"> <li>• 3-Punkt-Anbau Kat. I-II</li> <li>• Hydraulischer Verstellung Öffnen/Schließen</li> <li>• Pendelnder Kopf, um der Bodenoberfläche zu folgen</li> <li>• Federbelasteter Kopfrücklauf</li> <li>• Einstellung der Rückstellfederspannung</li> <li>• Sicherheitseinrichtungen nach CE-Normen</li> </ul>	<ul style="list-style-type: none"> <li>• Erganche a 3 punto Cat. I-II</li> <li>• Regulación hidráulica apertura/cierre</li> <li>• Cabeza flotante para seguir la duna del suelo</li> <li>• Cabezal interfilas con retorno a muelle</li> <li>• Ajuste de rigidez del retorno a muelle</li> <li>• Protecciones de seguridad de acuerdo con la norma CE</li> </ul>	<ul style="list-style-type: none"> <li>• Attelage 3 points Cat. I-II</li> <li>• Réglage hydraulique ouverture/fermeture</li> <li>• Disque satellite flottant adaptable au cours de le terrains</li> <li>• Retour à ressort disque satellite</li> <li>• Reglage rigidité du ressort</li> <li>• Protections contre les accidents aux normes CE</li> </ul>

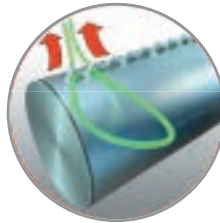
A richiesta	On request	Auf Anfrage	Opcionales	Sur demande
Kit attacco frontale per ITX versione doppia	Kit front attachment for ITX double version	Frontanbaukit für ITX Doppelte Ausführung	Kit acople frontal pour ITX versión doble	Kit de connexion avant pour ITX version double
	cod.	cat.	cm	kg
	2050924	II	-	27
				<b>790,00</b>



Sistema rapido per il cambio dei fili  
 Quick and tool-free wire replacement system  
 Schnelles und werkzeugloses Drahtwechselsystem  
 Sistema cambio de hilo rápido  
 Système rapide de remplacement du fil

MOD			
mod.	cod.	kg	euro
<b>DMI / TFZ</b>	1002882	280	<b>8.850,00</b>
<b>DMI / TMU</b>	1002884	280	<b>8.850,00</b>
<b>DMI / LFG</b>	1002886	280	<b>8.850,00</b>
<b>DMI / TFB</b>	1002887	280	<b>8.850,00</b>
<b>DMI / TFA / TFO</b>	1002888	280	<b>8.850,00</b>
<b>DMI / TRE</b>	1003005	280	<b>8.850,00</b>

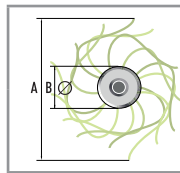

Ø A  
**450 mm**

Ø B  
**130 mm**

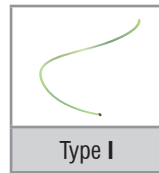

Di serie	Standard equipment	Serienmässig	Estándar	De série
<ul style="list-style-type: none"> <li>Seratoio da 40 litri indipendente</li> <li>Doppio sistema filtrante</li> <li>Kit attacco pompa</li> <li>Raccorderia oleodinamica con attacchi a sgancio rapido per una veloce rimozione della macchina</li> <li>Kit scambiatore di calore</li> <li>Posizioni di lavoro gestite direttamente dalla trattrice tramite Joystick multifunzione removibile</li> <li>Regolazione giri motore</li> <li>Blocco distribuzione gestito elettronicamente</li> <li>Accensione-spegnimento</li> <li>1 set di fili pre-installato</li> <li>Sistema rapido per il cambio dei fili</li> <li>Protezioni antinfortunistiche conformi alla normativa CE</li> </ul>	<ul style="list-style-type: none"> <li>Independent 40 liters tank</li> <li>Double filtering system</li> <li>Pump connection kit</li> <li>Hydraulic fittings with quick release connections for a quick removal of the machine</li> <li>Heat exchanger kit</li> <li>Working positions managed directly by the tractor using a removable multifunction joystick</li> <li>Engine revolutions adjustment</li> <li>Electronically managed distribution block</li> <li>On-off switching</li> <li>1 set of pre-installed wires</li> <li>Quick and tool-free wire replacement system</li> <li>Protective equipment as per EC safety rules</li> </ul>	<ul style="list-style-type: none"> <li>Unabhängiger 40Lt Tank</li> <li>Doppeltes Filtersystem</li> <li>Pumpenverbindingssatz</li> <li>Hydraulische Armaturen mit Schnellkupplungen für eine schnelle Demontage der Maschine</li> <li>Wärmetauscher-Kit</li> <li>Direkte Steuerung der Arbeitspositionen durch den Traktor mit einem abnehmbaren Multifunktions-Joystick</li> <li>Einstellung der Motordrehzahl</li> <li>Elektronisch gesteuerter Verteilerblock</li> <li>Ein-Aus-Schaltung</li> <li>1 Satz vorinstallierter Drähte</li> <li>Schnelles und werkzeugloses Drahtwechselsystem</li> <li>Unfallschutz nach EU-Vorschriften</li> </ul>	<ul style="list-style-type: none"> <li>Tanque de 40 litros independiente</li> <li>Doble sistema de filtrado</li> <li>Kit de conexión de bomba</li> <li>Accesorios hidráulicos con conexiones de liberación rápida para una rápida extracción de la máquina</li> <li>Kit de intercambiador de calor</li> <li>Posiciones de trabajo gestionadas directamente por el tractor mediante un joystick</li> <li>Ajuste de revoluciones del motor</li> <li>Bloque de distribución gestionado electrónicamente</li> <li>Encendido-apagado</li> <li>1 juego de cables preinstalados</li> <li>Sistema cambio de hilo rápido</li> <li>Protecciones de seguridad de acuerdo con la norma CE</li> </ul>	<ul style="list-style-type: none"> <li>Réservoir indépendant 40 litres</li> <li>Système de double filtration</li> <li>Kit de connexion de pompe</li> <li>Raccords hydrauliques avec raccords rapides pour un retrait rapide de la machine</li> <li>Kit échangeur de chaleur</li> <li>Positions de travail gérées directement par le tracteur à l'aide d'un joystick multifonction amovible</li> <li>Réglage de la rotation du moteur</li> <li>Bloc de distribution géré électroniquement</li> <li>Commutation marche-arrêt</li> <li>1 jeu de fils pré-installés</li> <li>Système rapide de remplacement du fil</li> <li>Protections contre les accidents aux normes CE</li> </ul>

cod.	Ricambi	Spare parts	Ersatzteile	Recambios	Pièces de rechange
5450043	Bobina filo 630 mt Ø 4 mm	Wire 630 mt Ø 4 mm	Garnrolle 630 mt Ø 4 mm	Hilo 630 mt Ø 4 mm	Bobine de fil 630 mt Ø 4 mm

<b>DMI</b>	<b>INTER-ROW WEEDER FOR FLAIL MOWER</b>
<b>DMI</b>	<b>MECHANISCHE UNKRAUTMÄHBÜRSTE FÜR MULCHER</b>
<b>DMI</b>	<b>DESBROZADORA INTERFILA MECÁNICA</b>
<b>DMI</b>	<b>MACHINE À ÉBOURGEONNER AVEC PALPEUR MÉCANIQUE</b>



ORIGINAL MADE IN ITALY

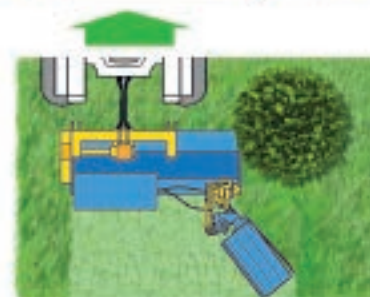
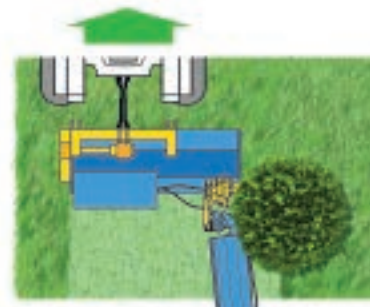
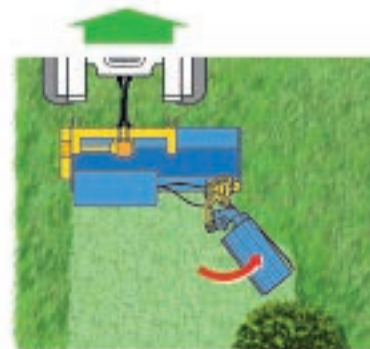
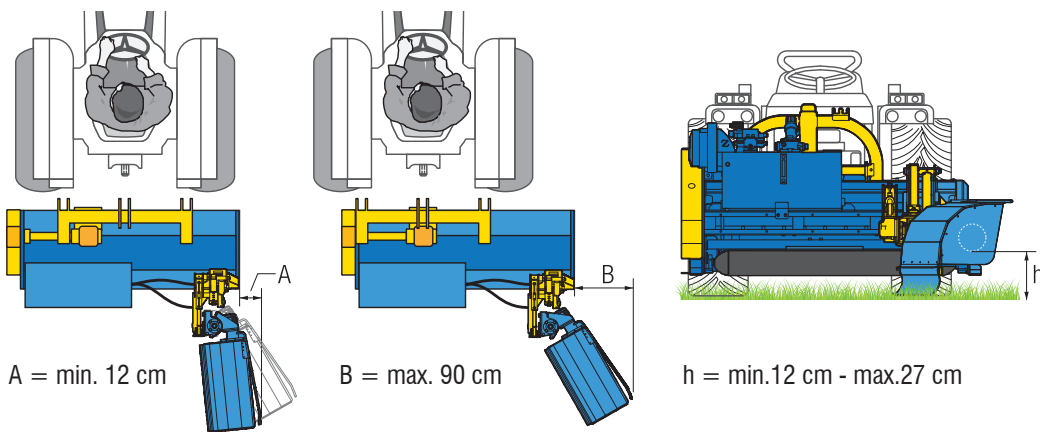

**MOVIMENTO 1 / MOVEMENT 1**



Apertura e chiusura braccio diserbatrice meccanica  
 Arm opening and closing  
 Antishock System: Anfahrssicherung  
 Apertura y cierre del brazo mecánico  
 Ouverture et fermeture du bras

**MOVIMENTO 2 / MOVEMENT 2**



Regolazione altezza asse rullo  
 Arm's height adjustment  
 Einstellung Arbeitsposition  
 Regulación de altura del rodillo  
 Réglage hauteur axe du rouleau



Sistema antishock regolabile per l'attenuazione dell'urto  
 Adjustable anti-shock system for shock absorption  
 Einstellbares Anfahrssicherung-System zur Stoßdämpfung  
 Sistema anti impacto regulable para amortiguar golpe  
 Système antichoc réglable pour atténuer l'impact



Rientro testata con sistema a molla  
 Movement with spring system  
 Schwenkung mit Federsystem  
 Cierre y apertura del cabezal con sistema de muelle  
 Retour de tête avec système de ressort



Regolazione giri rotore  
 Rotor speed control  
 Einstellung Rotorgeschwindigkeit  
 Regulación vueltas rotor  
 Réglage de la vitesse du rotor



DMI

## VERSIONE SINGOLA

SINGLE VERSION





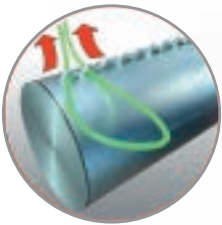
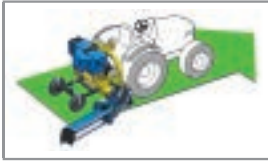

EINZELVERSION

VERSIÓN INDIVIDUAL

VERSION SIMPLE

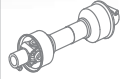
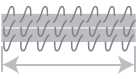

Sistema rapido per il cambio dei fili  
Quick and tool-free wire replacement system  
Schnelles und werkzeugloses Drahtwechselsystem  
Sistema cambio de hilo rápido  
Système rapide de remplacement du fil

MOD								
mod.	cod.	HP	rpm/min	type	cm	cm	kg	euro
<b>CST+DMI singola</b>	1002954	40 - 100	540	T-50 / T-60	75	165×175×110	460	<b>13.820,00</b>
<b>CST+DMI singola compatta</b>	1003032	40 - 100	540	T-50 / T-60	75	135×175×110	400	<b>14.940,00</b>

Di serie	Standard equipment	Serienmässig	Estándar	De série
<ul style="list-style-type: none"> <li>• Attacco a 3 punti Cat. I-II</li> <li>• Impianto oleodinamico completo di serbatoio, sistema filtrante e scambiatore di calore</li> <li>• Joystick multifunzione</li> <li>• Spostamento laterale idraulico apertura/chiusura</li> <li>• Regolazioni posizione rotore regolabili idraulicamente</li> <li>• Regolazione dei giri direttamente dal trattore</li> <li>• Sistema rapido per il cambio dei fili</li> <li>• Sistema antishock regolabile per l'attenuazione dell'urto</li> <li>• Ruote di appoggio con cresta regolabili in altezza</li> <li>• Protezioni antinfortunistiche conformi alla normativa CE</li> </ul>	<ul style="list-style-type: none"> <li>• 3-point linkage cat. I-II</li> <li>• Hydraulic system complete with tank, filter system and heat exchanger</li> <li>• Multifunction Joystick</li> <li>• Hydraulic side shift opening/closing</li> <li>• Hydraulically adjustable rotor positions</li> <li>• RPM adjustment directly from the tractor</li> <li>• Quick and tool-free wire replacement system</li> <li>• Adjustable anti-shock system for shock absorption</li> <li>• Height-adjustable crest wheels</li> <li>• Protective equipment as per EC safety rules</li> </ul>	<ul style="list-style-type: none"> <li>• 3-Punkt-Anbau Kat. I-II</li> <li>• Hydraulisches System komplett mit Tank, Filtersystem und Wärmetauscher</li> <li>• Multifunktions-Joystick</li> <li>• Hydraulische Seitenverschiebung öffnen/schließen</li> <li>• Hydraulisch einstellbare Rotorpositionen</li> <li>• Drehzahleinstellung direkt vom Traktor aus</li> <li>• Schnelles und werkzeugloses Drahtwechselsystem</li> <li>• Einstellbares Anfahrssicherungssystem zur Stoßdämpfung</li> <li>• Höhenverstellbare Räder mit Führung</li> <li>• Unfallschutz nach EU-Vorschriften</li> </ul>	<ul style="list-style-type: none"> <li>• Enganche a 3 punto Cat. I-II</li> <li>• Kit de centralita hidráulica completa de depósito, sistema filtrante e intercambiador de calor</li> <li>• Joystick multifunción</li> <li>• Desplazador lateral hidráulico apertura/cierre</li> <li>• Regulación posterior rotor regulable hidráulicamente</li> <li>• Regulación del número de vueltas desde el tractor</li> <li>• Sistema cambio de hilo rápido</li> <li>• Sistema anti impacto, regulable para amortiguar golpe</li> <li>• Rueda de apoyo con regulación en altura</li> <li>• Protecciones de seguridad de acuerdo con la norma CE</li> </ul>	<ul style="list-style-type: none"> <li>• Attelage 3 points Cat. I-II</li> <li>• Système hydraulique complet avec réservoir, système de filtrage et échangeur de chaleur</li> <li>• Joystick multifonction</li> <li>• Déplacement latéral hydraulique ouverture/fermeture</li> <li>• Réglage hydraulique position du rotor</li> <li>• Réglage de la vitesse géré directement de le tracteur</li> <li>• Système rapide de remplacement du fil</li> <li>• Système antichoc réglable pour atténuer l'impact</li> <li>• Roues de support avec guide réglables en hauteur</li> <li>• Protections contre les accidents aux normes CE</li> </ul>

cod.	A richiesta	On request	Auf Anfrage	Opcionales	Sur demande	€
5130005	Cardano T-50	PTO shaft T-50	Gelenkwelle T-50	Cardán T-50	Cardan T-50	<b>273,00</b>
5130009	Cardano T-60	PTO shaft T-60	Gelenkwelle T-60	Cardán T-60	Cardan T-60	<b>300,00</b>
5411041	Ruota in ferro senza cresta	Smooth iron wheel	Glatte Eisenräder	Rueda de hierro lisa	Roue en fer lisse	<b>90,00</b>

**CST+DMI SINGOLA**  
**CST+DMI SINGOLA**  
**CST+DMI SINGOLA**  
**CST+DMI SINGOLA**

*INDIPENDENT CASTLE with INTER-ROW MECHANICAL WEEDER*  
*MECHANISCHE UNKRAUTMÄHBÜRSTE*  
*DESBROZADORA INTERLÍNEAS MECÁNICA*  
*MACHINE Á ÉBOURGEONNER AVEC PALPEUR MÉCANIQUE*



ORIGINAL MADE IN ITALY

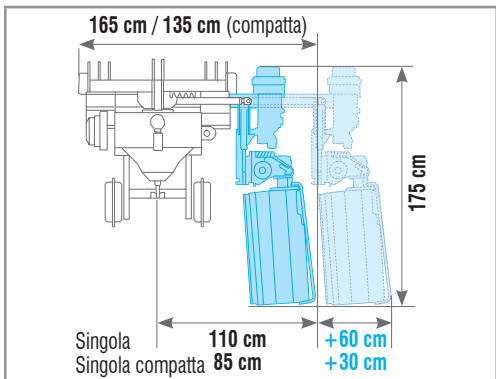
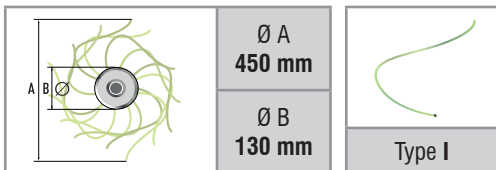

Sistema antishock regolabile per l'attenuazione dell'urto  
 Adjustable anti-shock system for shock absorption  
 Einstellbares Anfahrtsicherung-System zur Stoßdämpfung  
 Sistema anti impacto regulable para amortiguar golpe  
 Système antichoc réglable pour atténuer l'impact

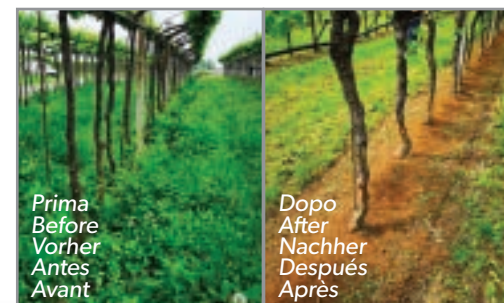
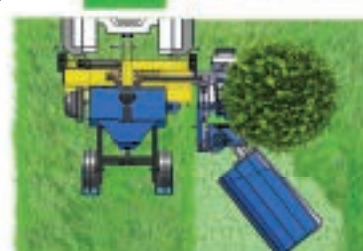
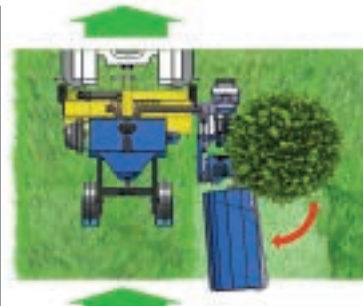

Scambiatore di calore  
 Heat exchanger  
 Wärmetauscher  
 Intercambiador de calor  
 Échangeur de chaleur



Joystick multifunzione con base magnetica  
 Multifunction Joystick with magnetic base  
 Multifunktions-Joystick bedienung mit magnet  
 Joystick multifunción con base magnética  
 Joystick multifonction avec base magnétique



cod.	Ricambi	Spare parts	Ersatzteile	Recambios	Pièces de rechange
5450043	Bobina filo 630 mt Ø 4 mm	Wire 630 mt Ø 4 mm	Garnrolle 630 mt Ø 4 mm	Hilo 630 mt Ø 4 mm	Bobine de fil 630 mt Ø 4 mm

## VERSIONE DOPPIA



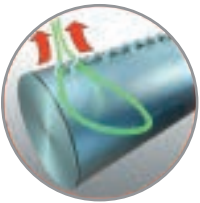
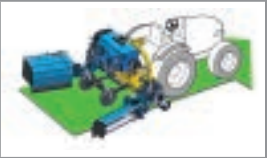



DOUBLE VERSION  
DOPPELTE VERSION  
VERSIÓN DOBLE  
VERSION DOUBLE



JOYSTICK MULTIFUNZIONE

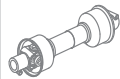
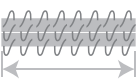

Sistema rapido per il cambio dei fili  
Quick and tool-free wire replacement system  
Schnelles und werkzeugloses Drahtwechselsystem  
Sistema cambio de hilo rápido  
Système rapide de remplacement du fil

MOD								
mod.	cod.	HP	rpm/min	type	cm	cm	kg	euro
<b>CST+DMI doppia</b>	1002955	50 - 100	540	T-50 / T-60	75	220×175×110	620	<b>22.140,00</b>
<b>CST+DMI doppia compatta</b>	1003033	50 - 100	540	T-50 / T-60	75	168×165×110	510	<b>23.910,00</b>

Di serie	Standard equipment	Serienmässig	Estándar	De série
<ul style="list-style-type: none"> <li>Attacco a 3 punti Cat. I-II</li> <li>Impianto oleodinamico completo di serbatoio, sistema filtrante e scambiatore di calore</li> <li>Joystick multifunzione</li> <li>Spostamento laterale idraulico apertura/chiusura</li> <li>Regolazioni posizione rotore regolabili idraulicamente</li> <li>Regolazione dei giri direttamente dal trattore</li> <li>Sistema rapido per il cambio dei fili</li> <li>Sistema antishock regolabile per l'attenuazione dell'urto</li> <li>Ruote di appoggio con cresta regolabili in altezza</li> <li>Protezioni antinfortunistiche conformi alla normativa CE</li> </ul>	<ul style="list-style-type: none"> <li>3-point linkage cat. I-II</li> <li>Hydraulic system complete with tank, filter system and heat exchanger</li> <li>Multifunction Joystick</li> <li>Hydraulic side shift opening/closing</li> <li>Hydraulically adjustable rotor positions</li> <li>RPM adjustment directly from the tractor</li> <li>Quick and tool-free wire replacement system</li> <li>Adjustable anti-shock system for shock absorption</li> <li>Height-adjustable crest wheels</li> <li>Protective equipment as per EC safety rules</li> </ul>	<ul style="list-style-type: none"> <li>3-Punkt-Anbau Kat. I-II</li> <li>Hydraulisches System komplett mit Tank, Filtersystem und Wärmetauscher</li> <li>Multifunktions-Joystick</li> <li>Hydraulische Seitenverschiebung öffnen/schließen</li> <li>Hydraulisch einstellbare Rotorpositionen</li> <li>Drehzahleinstellung direkt vom Traktor aus</li> <li>Schnelles und werkzeugloses Drahtwechselsystem</li> <li>Einstellbares Anfahrssicherungssystem zur Stoßdämpfung</li> <li>Höhenverstellbare Räder mit Führung</li> <li>Unfallschutz nach EU-Vorschriften</li> </ul>	<ul style="list-style-type: none"> <li>Enganche a 3 punto Cat. I-II</li> <li>Kit de centralita hidráulica completa de depósito, sistema filtrante e intercambiador de calor</li> <li>Joystick multifunción</li> <li>Desplazamiento lateral hidráulico apertura/cierre</li> <li>Regulación de la posición del rotor hidráulicamente</li> <li>Regulación del número de vueltas desde el tractor</li> <li>Sistema cambio de hilo rápido</li> <li>Sistema anti impacto, regulable para amortiguar golpe</li> <li>Rueda de apoyo con regulación en altura</li> <li>Protecciones de seguridad de acuerdo con la norma CE</li> </ul>	<ul style="list-style-type: none"> <li>Attelage 3 points Cat. I-II</li> <li>Système hydraulique complet avec réservoir, système de filtrage et échangeur de chaleur</li> <li>Joystick multifonction</li> <li>Déplacement latéral hydraulique ouverture/fermeture</li> <li>Réglages hydraulique de la position du rotor</li> <li>Réglage de la vitesse géré directement de le tracteur</li> <li>Système rapide de remplacement du fil</li> <li>Système antichoc réglable pour atténuer l'impact</li> <li>Roues de support avec guide réglables en hauteur</li> <li>Protections contre les accidents aux normes CE</li> </ul>

cod.	A richiesta	On request	Auf Anfrage	Opcionales	Sur demande	€
5130005	Cardano T-50	PTO shaft T-50	Gelenkwelle T-50	Cardán T-50	Cardan T-50	<b>273,00</b>
5130009	Cardano T-60	PTO shaft T-60	Gelenkwelle T-60	Cardán T-60	Cardan T-60	<b>300,00</b>
5411041	Ruota in ferro senza cresta	Smooth iron wheel	Glatte Eisenräder	Rueda de hierro lisa	Roue en fer lisse	<b>90,00</b>

CST+DMI DOPPIA

INDIPENDENT CASTLE with INTER-ROW MECHANICAL WEEDER

CST+DMI DOPPIA

MECHANISCHE UNKRAUTMÄHBÜRSTE

CST+DMI DOPPIA

DES BROZADORA INTERLÍNEAS MECÁNICA

CST+DMI DOPPIA

MACHINE À ÉBOURGEONNER AVEC PALPEUR MÉCANIQUE



ORIGINAL MADE IN ITALY

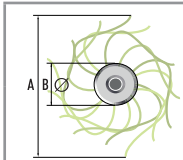

Ø A  
450 mm

Ø B  
130 mm

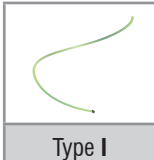

Type I

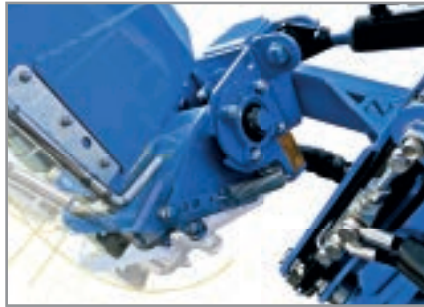

Sistema antishock regolabile per l'attenuazione dell'urto  
Adjustable anti-shock system for shock absorption  
Einstellbares Anfahrtsicherung-System zur Stoßdämpfung  
Sistema anti impacto regulable para amortiguar golpe  
Système antichoc réglable pour atténuer l'impact

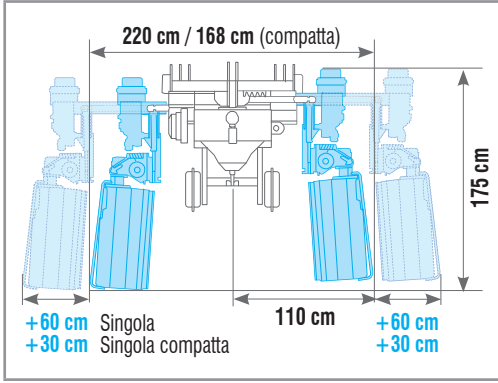
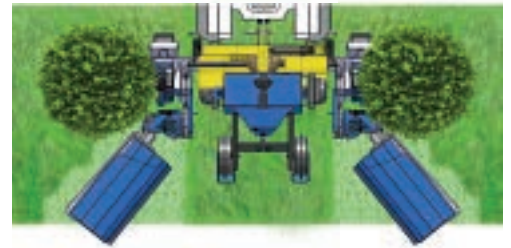
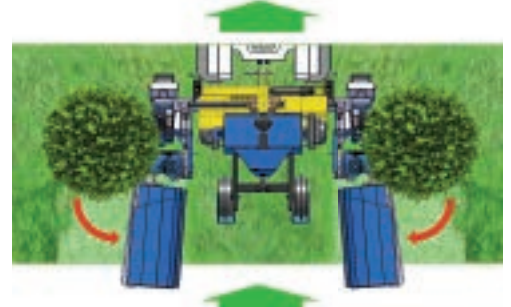

Regolazione giri rotore  
Rotor speed control  
Einstellung Rotorgeschwindigkeit  
Regulación vueltas rotor  
Réglage de la vitesse du rotor

Joystick multifunzione con base magnetica  
Multifunction Joystick with magnetic base  
Multifunktions-Joystick bedienung mit magnet  
Joystick multifunción con base magnética  
Joystick multifonction avec base magnétique



+60 cm Singola  
+30 cm Singola compatta







+60 cm  
+30 cm

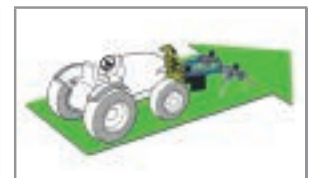
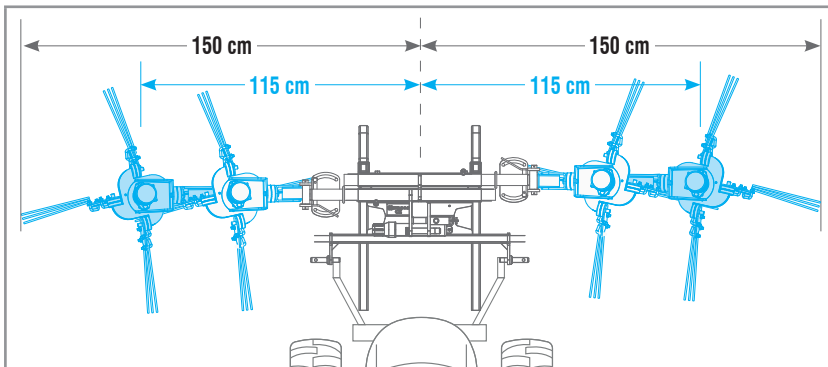
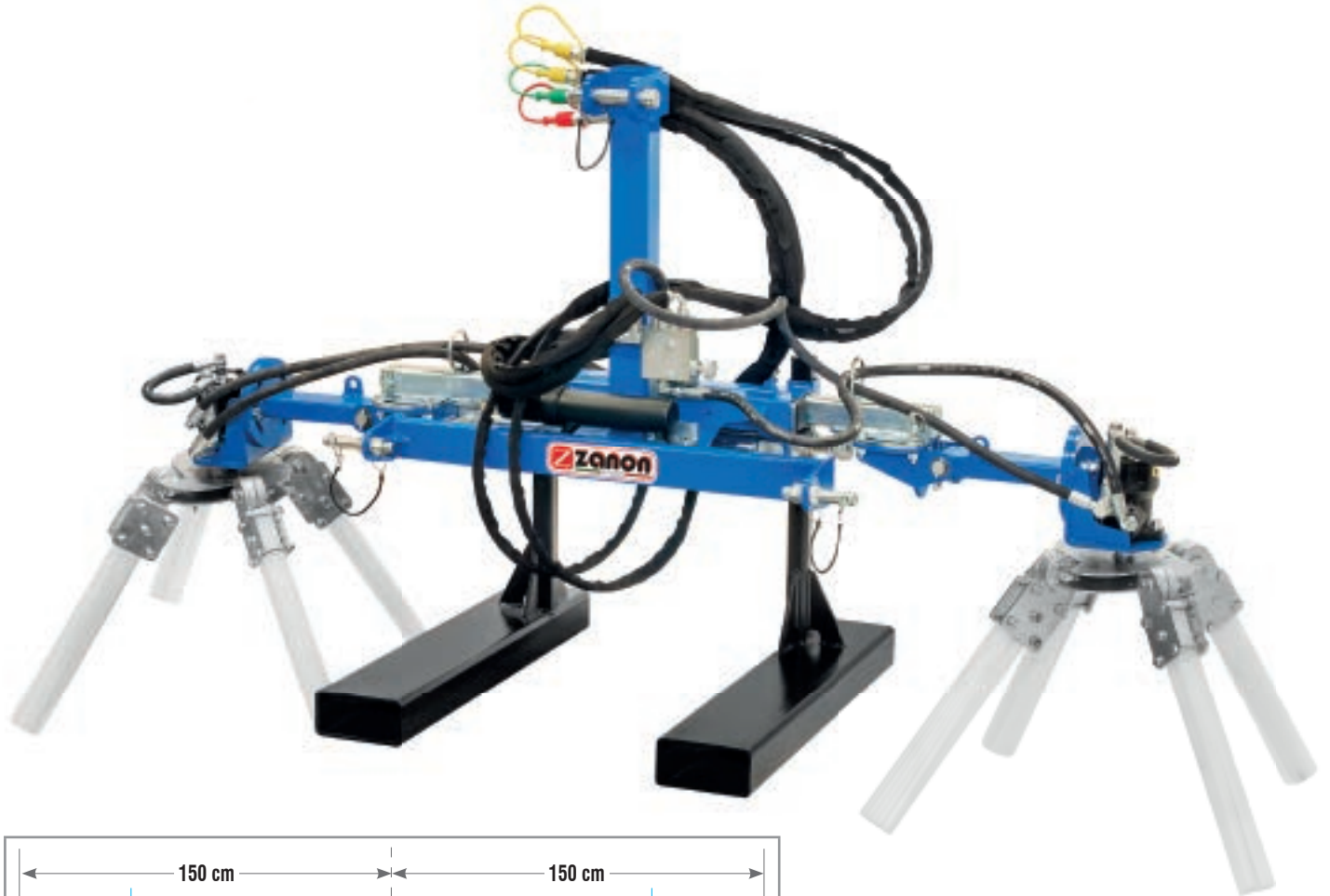

Scambiatore di calore  
Heat exchanger  
Wärmetauscher  
Intercambiador de calor  
Échangeur de chaleur

cod.	Ricambi	Spare parts	Ersatzteile	Recambios	Pièces de rechange
5450043	Bobina filo 630 mt Ø 4 mm	Wire 630 mt Ø 4 mm	Garnrolle 630 mt Ø 4 mm	Hilo 630 mt Ø 4 mm	Bobine de fil 630 mt Ø 4 mm



MOD						
mod.	cod.	HP	cm	l/min	kg	euro
AND-V singolo	1003849	30 - 100	163×70×130	30	140	3.940,00
AND-V doppio	1003850	30 - 100	230×70×130	40	185	4.620,00





<b>AND-V</b>	PRUNING SWEEP FOR VINEYARDS AND ORCHARDS
<b>AND-V</b>	KREISELSCHWADER FÜR REIHENKULTUREN
<b>AND-V</b>	HILERADORA DE PODA PARA VIÑEDOS Y FRUTALES
<b>AND-V</b>	ANDAINEURS POUR VIGNE ET ARBORICULTURE



Impiego	Use	Verwendung	Uso	Utilisation
<p>Andanatore AND-V, disponibile in versione singola o doppia, fissato in posizione frontale completo di due braccia raduna tralci idrauliche per la manutenzione e la pulizia dell'interfila di vigneti e frutteti.</p> <p>Gli elementi in nylon che compongono il gruppo spazzole con un diametro di Ø 8 mm garantiscono una pulizia precisa e accurata del sotto-fila permettendo di radunare i tralci della potatura verso il centro del filare per poi essere trinciati o raccolti agevolmente.</p> <p>L'altezza regolabile delle braccia e dell'inclinazione degli elementi in nylon permette l'uso dell'AND-V anche in presenza di frutti pendenti lungo la coltivazione senza il rischio di danneggiarli.</p>	<p>Pruning sweep AND-V, available in single or double version, fixed in the frontal position complete with two arms, it collects hydraulic branches for the maintenance and cleaning of the rows of vineyards and orchards.</p> <p>The nylon elements that make up the brush group with a diameter of Ø 8 mm guarantee precise and accurate cleaning of the sub-row, allowing the pruning shoots to be gathered towards the center of the row and then easily chopped or collected.</p> <p>The adjustable height of the arms and the inclination of the nylon elements allows the use of the AND-V even in the presence of fruit hanging along the crop without the risk of damaging them.</p>	<p>Hydraulischer Kreiselchwader AND-V, Ein- oder Doppelseitig, Frontanbau zum Reinigen von Reihenpflanzungen, Schnittholz, Blätter usw. aus der Baumreihe in die Mitte der Fahrgasse zu befördern. Die Nylonelemente, aus denen die Bürste mit einem Durchmesser von Ø 8 mm besteht, gewährleisten eine präzise und genaue Reinigung der Zwischenreihen, so dass die Beschneidungstrieb in der Mitte der Reihe gesammelt und anschließend leicht gehäckselt oder gesammelt werden können.</p> <p>Die einstellbare Höhe der Arme und die Neigung der Nylonelemente ermöglichen den Einsatz des AND-V auch bei hängenden Früchten, ohne diese zu beschädigen.</p>	<p>Hileradora de poda AND-V, disponible en versión de simple o doble brazo, adaptable a la parte frontal del tractor, permitiendo alinear los restos de poda, tanto de viñedos como de frutales.</p> <p>Los elementos de nylon que componen el grupo de cepillos, tienen un Ø 8 mm, garantizan un óptimo trabajo en el hilerado de la poda en el centro de la calle, facilitando el triturado o la recolección de los mismos.</p> <p>La altura regulable de los brazos y la inclinación de los elementos de nylon permite el uso de la AND-V en diferentes marcos de cultivos, sin riesgo de dañarlos.</p>	<p>Andaineur AND-V, disponible en version simple ou double, connecté en position frontale avec deux bras hydrauliques pour canaliser les branches et les sarments au centre de le rang.</p> <p>Utilisé pour l'entretien et le nettoyage de vignes et de vergers.</p> <p>Les éléments en nylon qui composent le groupe de brosses d'un diamètre de Ø 8 mm garantissent un nettoyage précis sous les rangs, ils permettant de rassembler les branches et les sarments vers le centre du rang au fin de un broyage plus efficace.</p> <p>La hauteur réglable des bras et l'inclinaison des éléments en nylon permettent l'utilisation de l'andaineur AND-V même en présence de fruits accrochés sans risque de les endommager.</p>

AND-V

Di serie	Standard equipment	Serienmässig	Estándar	De série
<ul style="list-style-type: none"> <li>Attacco a 3 punti Cat. I-II</li> <li>Regolazione dei giri del rotore direttamente dal trattore</li> <li>Estensione meccanica dei bracci</li> <li>Kit spazzole in nylon</li> <li>Protezioni antinfortunistiche conformi alla normativa CE</li> </ul>	<ul style="list-style-type: none"> <li>3-point linkage Cat. I-II</li> <li>Rotor speed adjustment directly from the tractor</li> <li>Mechanical extension of the arms</li> <li>Nylon brush kit</li> <li>Protective equipment as per EC safety rules</li> </ul>	<ul style="list-style-type: none"> <li>3-Punkt-Anbau Kat. I-II</li> <li>RotordrehzahlEinstellung direkt vom Schlepper aus</li> <li>Mechanische Verlängerung der Arme</li> <li>Nylonbürsten-Kit</li> <li>Unfallschutz nach EU-Vorschriften</li> </ul>	<ul style="list-style-type: none"> <li>Enganche a 3 punto Cat. I-II</li> <li>Ajuste de la velocidad del rotor directamente desde el tractor</li> <li>Extensión mecánica de los brazos</li> <li>Kit de cepillos de nylon</li> <li>Protecciones de seguridad de acuerdo con la norma CE</li> </ul>	<ul style="list-style-type: none"> <li>Attelage 3 points Cat. I-II</li> <li>Réglage de la vitesse du rotor directement depuis le tracteur</li> <li>Extension mécanique des bras</li> <li>Ensemble de brosses en nylon</li> <li>Protections contre les accidents aux normes CE</li> </ul>

cod.	A richiesta	On request	Auf Anfrage	Opcionales	Sur demande	€
2050011	Regolazione indipendente del braccio destro	Independent adjustment of the right arm	Unabhängiges Verstellsystem der rechten Arm	Regulación independiente del brazo derecho	Réglage indépendant du bras droit	315,50
2050791	Regolazione indipendente del braccio sinistro	Independent adjustment of the left arm	Unabhängiges Verstellsystem der linken Arms	Regulación independiente del brazo izquierdo	Réglage indépendant du bras gauche	315,50
2051326	Kit apertura simultanea bracci (solo per AND-V doppio)	Simultaneous arm opening kit (only for double AND-V)	Bausatz zum gleichzeitigen Öffnen der Arme (nur für Doppel-AND-V)	Kit de apertura simultánea de brazos (sólo para AND-V doble)	Kit ouverture simultanée des bras (uniquement pour AND-V double)	550,00

cod. 2050011  
**On request**

Regolazione indipendente del braccio destro  
Independent adjustment of the right arm  
Unabhängiges Verstellsystem der rechten Arm  
Regulación independiente del brazo derecho  
Réglage indépendant du bras droit



cod. 2050791  
**On request**





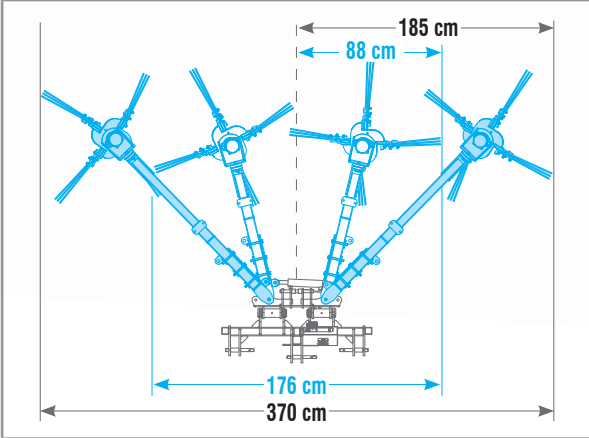

Regolazione indipendente del braccio sinistro  
Independent adjustment of the left arm  
Unabhängiges Verstellsystem der linken Arms  
Regulación independiente del brazo izquierdo  
Réglage indépendant du bras gauche



AND



**Standard equipment**  
 Joystick multifunzione  
 Multifunction joystick  
 Multifunktions-joystick  
 Joystick multifunción  
 Joystick multifonction

MOD						
mod.	cod.	HP	cm	l/min	kg	euro
<b>AND singolo</b>	1003812	30 - 100	120×140×128	25	148	<b>8.250,00</b>
<b>AND doppio</b>	1003813	30 - 100	140×140×128	50	198	<b>10.100,00</b>



<b>AND</b>	PRUNING SWEEP FOR VINEYARDS AND ORCHARDS
<b>AND</b>	KREISELSCHWADER FÜR REIHENKULTUREN
<b>AND</b>	HILERADORA DE PODA PARA VIÑEDOS Y FRUTALES
<b>AND</b>	ANDAINEURS POUR VIGNE ET ARBORICULTURE



Impiego	Use	Verwendung	Uso	Utilisation
<p>Andatore AND, disponibile in versione singola o doppia, fissato in posizione frontale completo di due braccia raduna tralci idrauliche per la manutenzione e la pulizia dell'interfila di vigneti e frutteti.</p> <p>Gli elementi in nylon che compongono il gruppo spazzole con un diametro di Ø 8 mm garantiscono una pulizia precisa e accurata del sotto-fila permettendo di radunare i tralci della potatura verso il centro del filare per poi essere trinciati o raccolti agevolmente.</p> <p>L'altezza regolabile delle braccia e dell'inclinazione degli elementi in nylon permette l'uso dell'AND anche in presenza di frutti pendenti lungo la coltivazione senza il rischio di danneggiarli.</p>	<p>Pruning sweep AND, available in single or double version, fixed in the frontal position complete with two arms, it collects hydraulic branches for the maintenance and cleaning of the rows of vineyards and orchards.</p> <p>The nylon elements that make up the brush group with a diameter of Ø 8 mm guarantee precise and accurate cleaning of the sub-row, allowing the pruning shoots to be gathered towards the center of the row and then easily chopped or collected.</p> <p>The adjustable height of the arms and the inclination of the nylon elements allows the use of the AND even in the presence of fruit hanging along the crop without the risk of damaging them.</p>	<p>Hydraulischer Kreiseleschwader AND, Ein- oder Doppelseitig, Frontanbau zum Reinigen von Reihenpflanzungen, Schnittholz, Blätter usw. aus der Baumreihe in die Mitte der Fahrgasse zu befördern. Die Nylonelemente, aus denen die Bürste mit einem Durchmesser von Ø 8 mm besteht, gewährleisten eine präzise und genaue Reinigung der Zwischenreihen, so dass die Beschneidungstrieb in der Mitte der Reihe gesammelt und anschließend leicht gehäckselt oder gesammelt werden können.</p> <p>Die einstellbare Höhe der Arme und die Neigung der Nylonelemente ermöglichen den Einsatz des AND auch bei hängenden Früchten, ohne diese zu beschädigen.</p>	<p>Hileradora de poda AND, disponible en versión de simple o doble brazo, adaptable a la parte frontal del tractor, permitiendo alinear los restos de poda, tanto de viñedos como de frutales.</p> <p>Los elementos de nylon que componen el grupo de cepillos, tienen un Ø 8 mm, garantizan un óptimo trabajo en el hilerado de la poda en el centro de la calle, facilitando el triturado o la recolección de los mismos.</p> <p>La altura regulable de los brazos y la inclinación de los elementos de nylon permite el uso de la AND en diferentes marcos de cultivos, sin riesgo de dañarlos.</p>	<p>Andaineur AND, disponible en version simple ou double, connecté en position frontale avec deux bras hydrauliques pour canaliser les branches et les sarmanants au centre de le rang. Utilisé pour l'entretien et le nettoyage de vignes et de vergers.</p> <p>Les éléments en nylon qui composent le groupe de brosses d'un diamètre de Ø 8 mm garantissent un nettoyage précis sous les rangs, ils permettant de rassembler les branches et les sarmanants vers le centre du rang au fin de un broyage plus efficace.</p> <p>La hauteur réglable des bras et l'inclinaison des éléments en nylon permettent l'utilisation de l'andaineur AND même en présence de fruits accrochés sans risque de les endommager.</p>

AND

Di serie	Standard equipment	Serienmässig	Estándar	De série
<ul style="list-style-type: none"> <li>Attacco a 3 punti Cat. II</li> <li>Comandi elettroidraulici</li> <li>Joystick multifunzione</li> <li>Regolazione dei giri del rotore direttamente dal trattore</li> <li>Estensione meccanica dei bracci</li> <li>Kit spazzole in nylon</li> <li>Protezioni antinfortunistiche conformi alla normativa CE</li> </ul>	<ul style="list-style-type: none"> <li>3-point linkage cat. II</li> <li>Electrohydraulic controls</li> <li>Multifunction Joystick</li> <li>Rotor speed adjustment directly from the tractor</li> <li>Mechanical extension of the arms</li> <li>Nylon brush kit</li> <li>Protective equipment as per EC safety rules</li> </ul>	<ul style="list-style-type: none"> <li>3-Punkt-Anbau Kat. II</li> <li>Elektrohydraulische Steuerung</li> <li>Multifunktions-Joystick</li> <li>Rotordrehzahleinstellung direkt vom Schlepper aus</li> <li>Mechanische Verlängerung der Arme</li> <li>Nylonbürsten-Kit</li> <li>Unfallschutz nach EU-Vorschriften</li> </ul>	<ul style="list-style-type: none"> <li>Enganche a 3 punto Cat. II</li> <li>Controles electrohidráulicos</li> <li>Joystick multifunción</li> <li>Ajuste de la velocidad del rotor directamente desde el tractor</li> <li>Extensión mecánica de los brazos</li> <li>Kit de cepillos de nylon</li> <li>Protecciones de seguridad de acuerdo con la norma CE</li> </ul>	<ul style="list-style-type: none"> <li>Attelage 3 points Cat. II</li> <li>Commandes électro-hydrauliques</li> <li>Joystick multifonctionnel</li> <li>Réglage de la vitesse du rotor directement depuis le tracteur</li> <li>Extension mécanique des bras</li> <li>Ensemble de brosses en nylon</li> <li>Protections contre les accidents aux normes CE</li> </ul>

cod.	A richiesta	On request	Auf Anfrage	Opcionales	Sur demande	€
2051256	Palette in gomma	Rubber vanes	Gummilappen	Paletas de goma	Palettes en caoutchouc	565,00
2051254	Kit ruota	Wheel kit	Räder-Kit	Kit rueda	Kit roue	545,00
5230993	Piastra per staffaggio su porta zavorra anteriore	Plate for mounting on the front ballast holder	Platte zur Montage am vorderen Ballasthalter	Placa para montaje en soporte de los contra pesos delanteros del tractor	Plaque de montage sur support de ballast frontal	67,50
2051276	Regolazione indipendente dei bracci (solo versione doppia)	Independent adjustment of the arms (double version only)	Unabhängiges Verstellsystem der Arme (nur bei der Doppelversion)	Regulación independiente de los brazos, solo versión de doble brazo	Réglage indépendant des bras (version double uniquement)	840,00

cod. 2051256  
**On request**  
 Palette in gomma  
 Rubber vanes  
 Gummilappen  
 Paletas de goma  
 Palettes en caoutchouc

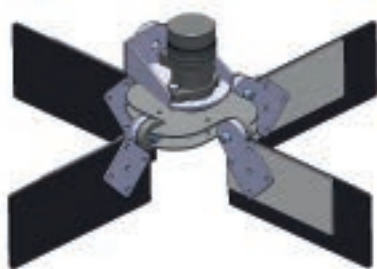

Q.ty 1 × singolo  
 Q.ty 2 × doppio

cod. 5230993  
**On request**  
 Piastra per staffaggio su porta zavorra anteriore  
 Plate for mounting on the front ballast holder  
 Platte zur Montage am vorderen Ballasthalter  
 Placa para montaje en soporte de los contra pesos delanteros  
 Plaque de montage sur support de ballast frontal



cod. 2051254  
**On request**  
 Kit ruota  
 Wheel kit  
 Räder-Kit  
 Kit rueda  
 Kit roue



Q.ty 1 × singolo  
 Q.ty 2 × doppio

cod. 2051276  
**On request**  
 Regolazione indipendente dei bracci (solo versione doppia)  
 Independent adjustment of the arms (double version only)  
 Unabhängiges Verstellsystem der Arme (nur bei der Doppelversion)  
 Regulación independiente de los brazos, solo versión de doble brazo  
 Réglage indépendant des bras (version double uniquement)



### VERSIONE STANDARD

STANDARD VERSION

STANDARD VERSION

VERSIÓN ESTÁNDAR

VERSION STANDARD

**UTENSILI vedere a pag. 240**

TOOLS see page 240

WERKZEUGE siehe Seite 240

HERRAMIENTAS ver página 240

OUTILS voir page 240

**TOP SPEED**  
**15 km/h**

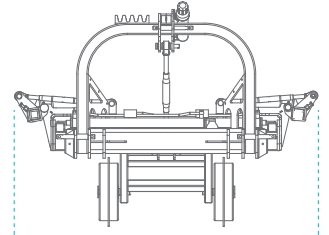

160 cm

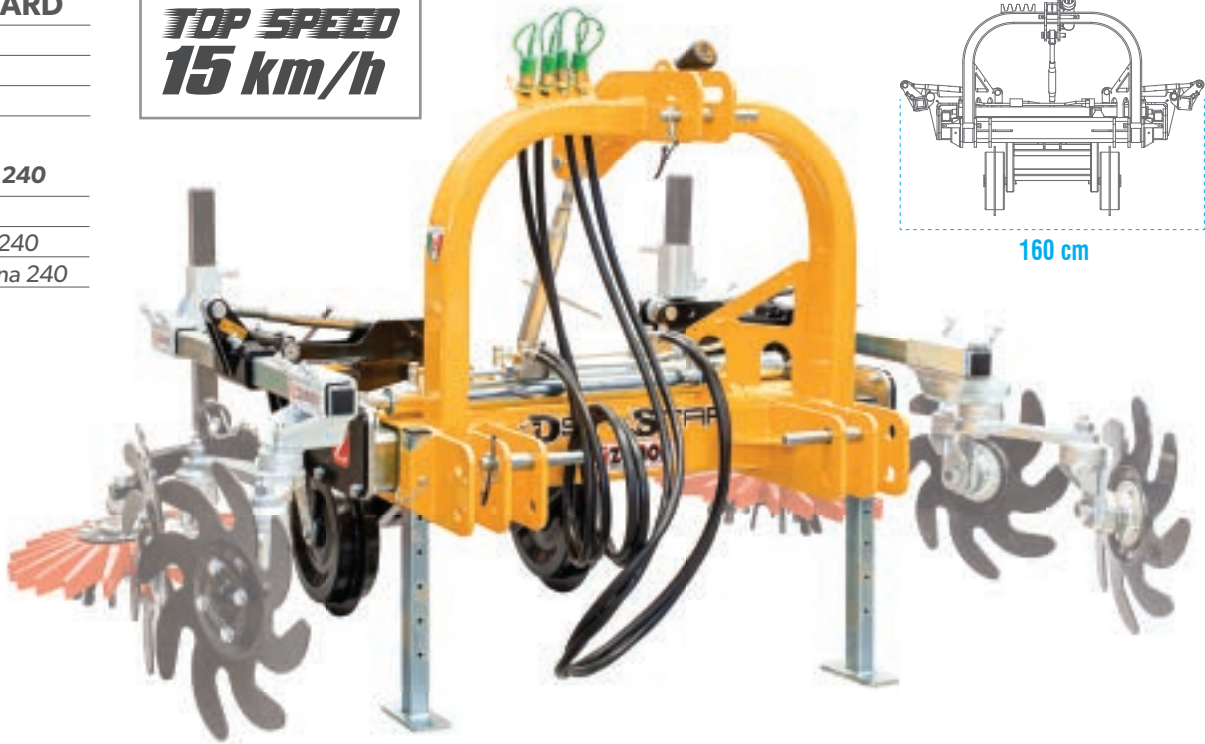

L'immagine della macchina è indicativa. Gli utensili e gli accessori sono a richiesta. – The picture of the machine is indicative. Tools and accessories are on request.

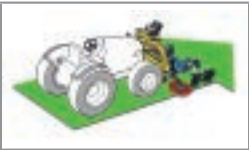

+60 cm



**DST-STAR Singola**

+60 cm

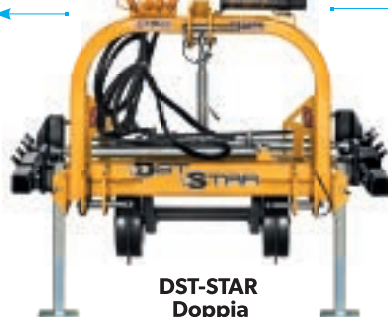

**DST-STAR Doppia**

+60 cm

+60 cm

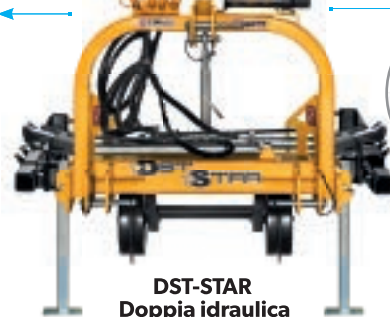

**DST-STAR Doppia idraulica**

+60 cm



**MOD**



mod.

cod.

HP

cm

kg

euro

**DST-STAR singola**

1002993

30 - 100

150×120×100

350

**3.600,00**

**DST-STAR doppia**

1002994

30 - 100

200×120×100

400

**4.650,00**

**DST-STAR doppia idraulica**

1002996

30 - 100

200×120×100

425

**6.750,00**

Di serie	Standard equipment	Serienmässig	Estándar	De série		
<ul style="list-style-type: none"> <li>Attacco a 3 punti Cat. I-II</li> <li>Spostamento laterale idraulico apertura/chiusura</li> <li>Ruote di appoggio con cresta regolabili in altezza</li> <li>Joystick di comando con kit regolazione idraulica angolo di lavoro (solo su versione idraulica)</li> <li>Protezioni antinfortunistiche conformi alla normativa CE</li> </ul>	<ul style="list-style-type: none"> <li>3-point linkage cat. I-II</li> <li>Hydraulic side shift opening/closing</li> <li>Height-adjustable crest wheels</li> <li>Hydraulic kit with magnetic-base joystick for work angle (only on hydraulic version)</li> <li>Protective equipment as per EC safety rules</li> </ul>	<ul style="list-style-type: none"> <li>3-Punkt-Anbau Kat. I-II</li> <li>Hydraulische Seitenverschiebung öffnen/schließen</li> <li>Höhenverstellbare Räder mit Führung</li> <li>Hydraulikeinheit mit Joystick -Arbeitswinkel (nur bei hydraulischer Ausführung)</li> <li>Unfallschutz nach EU-Vorschriften</li> </ul>	<ul style="list-style-type: none"> <li>Enganche a 3 punto Cat. I-II</li> <li>Desplazamiento lateral hidráulico apertura/cierre</li> <li>Rueda de apoyo con regulación en altura</li> <li>Kit hidráulico con joystick para ángulo de trabajo (solo en versión hidráulica)</li> <li>Protecciones de seguridad de acuerdo con la norma CE</li> </ul>	<ul style="list-style-type: none"> <li>Attelage 3 points Cat. I-II</li> <li>Déplacement latéral hydraulique ouverture/fermeture</li> <li>Roues de support avec guide réglables en hauteur</li> <li>Kit hydraulique équipé de joystick pour angle de travail (uniquement sur la version hydraulique)</li> <li>Protections contre les accidents aux normes CE</li> </ul>		
cod.	A richiesta	On request	Auf Anfrage	Opcionales	Sur demande	€
5411041	Ruota in ferro senza cresta	Smooth iron wheel	Glatte Eisenräder	Rueda de hierro lisa	Roue en fer lisse	<b>90,00</b>
2050703	Kit attacco frontale	Kit front attachment	Frontanbaukit	Kit acople frontal	Kit de connexion avant	<b>740,00</b>

**DST-STAR**

WEEDER WITH FINGER HOE AND FINGER ROLLER

**DST-STAR**

RAHMEN MIT FINGERHACKE UND ROLLHACKE

**DST-STAR**

MARCO CON AZADA DE DEDO Y AZADA DE RODILLO

**DST-STAR**

CHÂSSIS AVEC HOUSSE À DOIGTS ET HOUSSE À ROULEAUX



ORIGINAL MADE IN ITALY

**VERSIONE COMPATTA**

NARROW VERSION

SCHMALE VERSION

VERSIÓN ESTRECHA

VERSION ÉTROITE

**UTENSILI vedere a pag. 240**

TOOLS see page 240

WERKZEUGE siehe Seite 240

HERRAMIENTAS ver página 240

OUTILS voir page 240

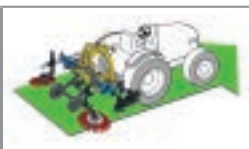
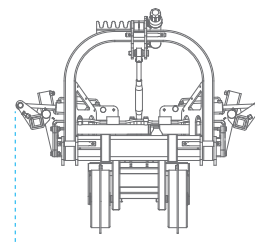
**TOP SPEED**  
**15 km/h**

130 cm

**VERSIONE COMPATTA**  
**NARROW VERSION**

L'immagine della macchina è indicativa. Gli utensili e gli accessori sono a richiesta. – The picture of the machine is indicative. Tools and accessories are on request.

+30 cm

**DST-STAR**  
**Doppia**

+30 cm

+30 cm

**DST-STAR**  
**Doppia idraulica****MOD**

mod.

cod.

HP

cm

kg

euro

**DST-STAR doppia compatta**

1003068

30 - 100

130×115×100

240

**4.160,00****DST-STAR doppia compatta idraulica**

1003069

30 - 100

130×115×100

260

**6.130,00**

Di serie	Standard equipment	Serienmässig	Estándar	De série		
<ul style="list-style-type: none"> <li>Attacco a 3 punti Cat. I</li> <li>Spostamento laterale idraulico apertura/chiusura</li> <li>Ruote di appoggio con cresta regolabili in altezza</li> <li>Joystick di comando con kit regolazione idraulica angolo di lavoro (solo su versione idraulica)</li> <li>Protezioni antinfortunistiche conformi alla normativa CE</li> </ul>	<ul style="list-style-type: none"> <li>3-point linkage cat. I</li> <li>Hydraulic side shift opening/closing</li> <li>Height-adjustable crest wheels</li> <li>Hydraulic kit with magnetic-base joystick for work angle (only on hydraulic version)</li> <li>Protective equipment as per EC safety rules</li> </ul>	<ul style="list-style-type: none"> <li>3-Punkt-Anbau Kat. I</li> <li>Hydraulische Seitenverschiebung öffnen/schließen</li> <li>Höhenverstellbare Räder mit Führung</li> <li>Hydraulikeinheit mit Joystick -Arbeitswinkel (nur bei hydraulischer Ausführung)</li> <li>Unfallschutz nach EU-Vorschriften</li> </ul>	<ul style="list-style-type: none"> <li>Enganche a 3 punto Cat. I</li> <li>Desplazamiento lateral hidráulico apertura/cierre</li> <li>Rueda de apoyo con regulación en altura</li> <li>Kit hidráulico con joystick para ángulo de trabajo (solo en versión hidráulica)</li> <li>Protecciones de seguridad de acuerdo con la norma CE</li> </ul>	<ul style="list-style-type: none"> <li>Attelage 3 points Cat. I</li> <li>Déplacement latéral hydraulique ouverture/fermeture</li> <li>Roues de support avec guide réglables en hauteur</li> <li>Kit hydraulique équipé de joystick pour angle de travail (uniquement sur la version hydraulique)</li> <li>Protections contre les accidents aux normes CE</li> </ul>		
cod.	A richiesta	On request	Auf Anfrage	Opcionales	Sur demande	€
5411041	Ruota in ferro senza cresta	Smooth iron wheel	Glatte Eisenräder	Rueda de hierro lisa	Roue en fer lisse	<b>90,00</b>
2050784	Kit attacco frontale	Kit front attachment	Frontanbaukit	Kit acople frontal	Kit de connexion avant	<b>690,00</b>





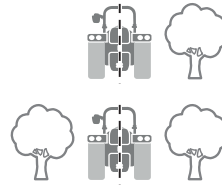

### UTENSILI

WORKING TOOLS  
WERKZEUGE  
HERRAMIENTAS DE TRABAJO  
OUTILS DE TRAVAIL



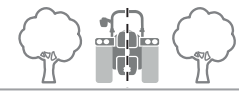





Le larghezze di lavoro si riferiscono alle macchine STANDARD.  
Per i modelli COMPATTI si devono togliere 18 cm a destra e/o a sinistra.  
The working widths refer to STANDARD machines.  
For COMPACT models, 18 cm must be removed on the right and/or left.  
Die Arbeitsbreiten beziehen sich auf STANDARD-Maschinen.  
Bei COMPACT-Modellen müssen rechts und / oder links 18 cm entfernt werden.  
Los anchos de trabajo se refieren a máquinas ESTÁNDAR.  
Para los modelos COMPACT, se deben quitar 18 cm a la derecha y/o a la izquierda.  
Les largeurs de travail se réfèrent aux machines STANDARD. Pour les modèles COMPACT, doivent être retirés 18 cm à droite et / ou à gauche.



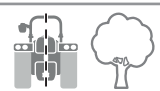
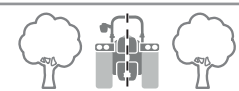



Ø 540

Disco sarchiatore a dita Disco stella Ø 540 Densità dura - Colore rosso	Finger weeder Star disc Ø 540 Hard density - Red color	Fingerhacke Sternscheibe Ø 540 Harte Dichte - Rote Farbe	Disco cultivador a dedos Disco estrella Ø 540 Densidad dura - Color rojo	Disque sarclage à doigts Disque étoile Ø 540 Densité dure - Couleur rouge		
						
cod.	cm	cm	l/min	kg	euro	
2050647 DX	105	105   105	--	30	1.750,00	
2050647 SX	165	165   165	--	30	1.750,00	



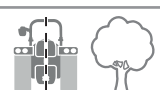
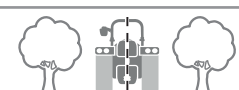



Ø 700

Disco sarchiatore a dita Disco stella Ø 700 Densità dura - Colore rosso	Finger weeder Star disc Ø 700 Hard density - Red color	Fingerhacke Sternscheibe Ø 700 Harte Dichte - Rote Farbe	Disco cultivador a dedos Disco estrella Ø 700 Densidad dura - Color rojo	Disque sarclage à doigts Disque étoile Ø 700 Densité dure - Couleur rouge		
						
cod.	cm	cm	l/min	kg	euro	
2050644 DX	112	112   112	--	45	2.370,00	
2050644 SX	172	172   172	--	45	2.370,00	

Ø 540

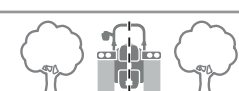
Disco sarchiatore a dita Disco stella Ø 540 Densità media - Colore giallo	Finger weeder Star disc Ø 540 Medium density - Yellow color	Fingerhacke Sternscheibe Ø 540 Mittlere Dichte - Gelbe Farbe	Disco cultivador a dedos Disco estrella Ø 540 Densidad media - Color amarillo	Disque sarclage à doigts Disque étoile Ø 540 Densité moyenne - Couleur jaune		
						
cod.	cm	cm	l/min	kg	euro	
2050648 DX	105	105   105	--	30	1.750,00	
2050648 SX	165	165   165	--	30	1.750,00	

Ø 700

Disco sarchiatore a dita Disco stella Ø 700 Densità media - Colore giallo	Finger weeder Star disc Ø 700 Medium density - Yellow color	Fingerhacke Sternscheibe Ø 700 Mittlere Dichte - Gelbe Farbe	Disco cultivador a dedos Disco estrella Ø 700 Densidad media - Color amarillo	Disque sarclage à doigts Disque étoile Ø 700 Densité moyenne - Couleur jaune		
						
cod.	cm	cm	l/min	kg	euro	
2050645 DX	112	112   112	--	45	2.370,00	
2050645 SX	172	172   172	--	45	2.370,00	

<b>DST-STAR</b>	WEEDER WITH FINGER HOE AND FINGER ROLLER
<b>DST-STAR</b>	RAHMEN MIT FINGERHACKE UND ROLLHACKE
<b>DST-STAR</b>	MARCO CON AZADA DE DEDO Y AZADA DE RODILLO
<b>DST-STAR</b>	CHÂSSIS AVEC HOUSSE À DOIGTS ET HOUSSE À ROULEAUX



ORIGINAL MADE IN ITALY

# UTENSILI

## WORKING TOOLS

## WERKZEUGE

## HERRAMIENTAS DE TRABAJO



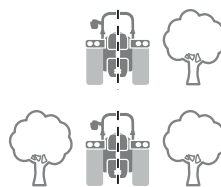



## OUTILS DE TRAVAIL





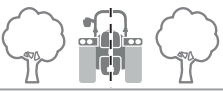



Le larghezze di lavoro si riferiscono alle macchine STANDARD.  
Per i modelli COMPATTI si devono togliere 18 cm a destra e/o a sinistra.  
The working widths refer to STANDARD machines.  
For COMPACT models, 18 cm must be removed on the right and/or left.  
Die Arbeitsbreiten beziehen sich auf STANDARD-Maschinen.  
Bei COMPACT-Modellen müssen rechts und / oder links 18 cm entfernt werden.  
Los anchos de trabajo se refieren a máquinas ESTÁNDAR.  
Para los modelos COMPACT, se deben quitar 18 cm a la derecha y/o a la izquierda.  
Les largeurs de travail se réfèrent aux machines STANDARD. Pour les modèles COMPACT, doivent être retirés 18 cm à droite et / ou à gauche.

DST-STAR UTENSILI



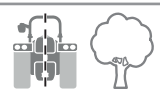



Ø 1000

Disco sarchiatore a dita Disco stella Ø 1000 Densità media - Colore giallo	Finger weeder Star disc Ø 1000 Medium density - Yellow color	Fingerhackle Sternscheibe Ø 1000 Mittlere Dichte - Gelbe Farbe	Disco cultivador a dedos Disco estrella Ø 1000 Densidad media - Color amarillo	Disque sarclage à doigts Disque étoile Ø 1000 Densité moyenne - Couleur jaune			
							
cod.	cm	cm	l/min	kg	euro		
2050642 DX	128	128   128	--	67	3.190,00		
2050642 SX	188	188   188	--	67	3.190,00		



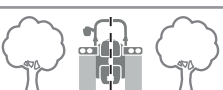



Ø 540

Disco sarchiatore a dita Disco stella Ø 540 Densità morbida - Colore arancione	Finger weeder Star disc Ø 540 Soft density - Orange color	Fingerhackle Sternscheibe Ø 540 Weiche Dichte - Orange Farbe	Disco cultivador a dedos Disco estrella Ø 540 Densidad suave - Color naranja	Disque sarclage à doigts Disque étoile Ø 540 Densité douce - Couleur orange			
							
cod.	cm	cm	l/min	kg	euro		
2050649 DX	105	105   105	--	30	1.750,00		
2050649 SX	165	165   165	--	30	1.750,00		

Ø 700

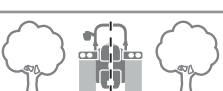
Disco sarchiatore a dita Disco stella Ø 700 Densità morbida - Colore arancione	Finger weeder Star disc Ø 700 Soft density - Orange color	Fingerhackle Sternscheibe Ø 700 Weiche Dichte - Orange Farbe	Disco cultivador a dedos Disco estrella Ø 700 Densidad suave - Color naranja	Disque sarclage à doigts Disque étoile Ø 700 Densité douce - Couleur orange			
							
cod.	cm	cm	l/min	kg	euro		
2050646 DX	112	112   112	--	45	2.370,00		
2050646 SX	172	172   172	--	45	2.370,00		

Ø 1000

Disco sarchiatore a dita Disco stella Ø 1000 Densità morbida - Colore arancione	Finger weeder Star disc Ø 1000 Soft density - Orange color	Fingerhackle Sternscheibe Ø 1000 Weiche Dichte - Orange Farbe	Disco cultivador a dedos Disco estrella Ø 1000 Densidad suave - Color naranja	Disque sarclage à doigts Disque étoile Ø 1000 Densité douce - Couleur orange			
							
cod.	cm	cm	l/min	kg	euro		
2050643 DX	128	128   128	--	67	3.190,00		
2050643 SX	188	188   188	--	67	3.190,00		







**Kit lama paraterra  
posteriore per DST-STAR**

**Kit soil & stone deflector  
rear for DST-STAR**

**Kit Erd- & Steinschieber  
hinteres für DST-STAR**

**Kit cuchilla para-tierra  
trasero para DST-STAR**

**Kit lame convoyeur de terre  
arrière pour DST-STAR**

						
	cod.	cm	cm	l/min	kg	euro
	2051179 DX	90	90 : 90	--	25	920,00
2051180 SX	150	150 : 150	--	25	920,00	







**Disco anteriore rollhacke**

**Rollhacke front disc**

**Rollhacke front**

**Disco anterior rollhacke**

**Disque anterior rollhacke**

						
	cod.	cm	cm	l/min	kg	euro
	2050675 DX	85	85 : 85	--	14	760,00
2050676 SX	145	145 : 145	--	14	760,00	







**Disco anteriore rollhacke  
doppio "BOOMERANG"**

**Double rollhacke front discs  
"BOOMERANG"**

**Doppel-Rollhacke front  
"BOOMERANG"**

**Disco anterior rollhacke doble  
"BOOMERANG"**

**Disque anterior rollhacke  
double "BOOMERANG"**

						
	cod.	cm	cm	l/min	kg	euro
	2050639 DX	102	102 : 102	--	29	1.280,00
2050640 SX	162	162 : 162	--	29	1.280,00	







**Kit attacco frontale**

**Kit front attachment**

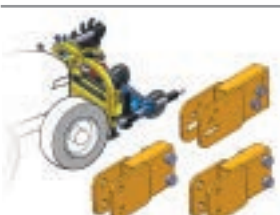
**Frontanbaukit**

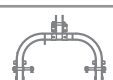
**Kit acople frontal**

**Kit de connexion avant**

					
	cod.	cat.	cm	kg	euro
	2050703 *	II	-	27	740,00
2050784 **	I - II	-	30	690,00	

\* per versione standard  
\*\* per versione compatta

\* for standard version  
\*\* for narrow version

\* für standard version  
\*\* für schmale version

\* para versión estándar  
\*\* para versión estrecha

\* pour la version standard  
\*\* pour la version étroite







**Kit rullo pacciamante  
completo di telaio**

**Mulching roller  
with frame**

**Mulchwalze  
mit Rahmen**

**Kit rodillo para mantillo  
completo de bastidor**

**Kit rouleau pour paillis  
avec châssis**

					
	cod.	cm	cm	kg	euro
	2050894	140	48	180	2.620,00
	2050896	160	48	190	2.900,00
2050897	180	48	200	3.150,00	





1964  
2024

# 60

ANNIVERSARY



## VERSIONE STANDARD

STANDARD VERSION

STANDARD VERSION

VERSIÓN ESTÁNDAR

VERSION STANDARD

**UTENSILI vedere a pag. 246**

TOOLS see page 246

WERKZEUGE siehe Seite 246

HERRAMIENTAS ver página 246

OUTILS voir page 246

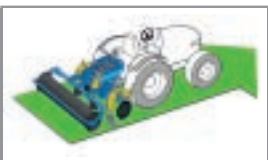

## DCV-VARIO

L'immagine della macchina è indicativa. Gli utensili e gli accessori sono a richiesta.  
The picture of the machine is indicative. Tools and accessories are on request.

MOD								
mod.	cod.	HP	cm	cm	nr cm	cm	kg	euro
<b>DCV-F 140</b>	1002976	60 - 100	40	140	2 600	187×175×130	260	<b>4.550,00</b>
<b>DCV-F 160</b>	1002977	80 - 100	40	160	2 600	207×175×130	360	<b>4.950,00</b>
<b>DCV-VARIO</b>	1002975	80 - 100	40	140 - 180	2 600	165×175×130	420	<b>5.950,00</b>

Di serie	Standard equipment	Serienmässig	Estándar	De série
<ul style="list-style-type: none"> <li>• Attacco a 3 punti Cat. II</li> <li>• 2 ancore per profondità fino a 40 cm con bullone di sicurezza</li> <li>• Apertura idraulica delle ancore laterali (solo per modello DCV-VARIO)</li> <li>• Protezioni antinfortunistiche conformi alla normativa CE</li> </ul>	<ul style="list-style-type: none"> <li>• 3-point linkage cat. II</li> <li>• 2 anchors for depths up to 40 cm with safety bolt</li> <li>• Hydraulic working width adjustment of side anchors (only for DCV-VARIO model)</li> <li>• Protective equipment as per EC safety rules</li> </ul>	<ul style="list-style-type: none"> <li>• 3-Punkt-Anbau Kat. II</li> <li>• 2 Zinken für Tiefen bis zu 40 cm mit Sicherungsbolzen</li> <li>• Hydraulische Arbeitsbreitenverstellung der Seitenzinken (nur bei Modell DCV-VARIO)</li> <li>• Unfallschutz nach EU-Vorschriften</li> </ul>	<ul style="list-style-type: none"> <li>• Eenganche a 3 punto Cat. II</li> <li>• 2 puntas para profundidad, hasta 40 cm, con bulón de seguridad</li> <li>• Apertura hidráulica de las puntas laterales (solo para modelo DCV-VARIO)</li> <li>• Protecciones de seguridad de acuerdo con la norma CE</li> </ul>	<ul style="list-style-type: none"> <li>• Attelage 3 points Cat. II</li> <li>• 2 ancras des profondeurs jusqu'à 40 cm avec boulon de sécurité</li> <li>• Ouverture hydraulique des ancras latéraux (seulement pour le modèle DCV-VARIO)</li> <li>• Protections contre les accidents aux normes CE</li> </ul>

## DCV-VARIO



DCV-VARIO DCV-F  
 DCV-VARIO DCV-F  
 DCV-VARIO DCV-F  
 DCV-VARIO DCV-F

SOIL LOOSENER FOR VINEYARD  
 TIEFENLOCKERER FÜR WEINBERGE  
 DESCOMPACTADOR VIÑEDO  
 DÉCOMPACTEUR VIGNERON



Impiego Use Verwendung Uso Utilisation

Il decompattatore da vigneto è una macchina progettata principalmente per vigneti e frutteti che permette di mantenere inalterata la parte superficiale del terreno e allo stesso tempo eliminare la suola di lavorazione o il compattamento dovuto al costante transito dei macchinari, aumentando notevolmente le capacità drenanti e il benessere delle piante. Il robusto telaio supporta delle ancore che possono raggiungere, a seconda della tipologia, fino a 40 cm di profondità.

The soil loosener for vineyard is designed mainly for vineyards and orchards, to keep the soil surface unaltered while removing the hardpan or the compaction due to the constant transit of machinery, thus greatly increasing the draining capacity of soil and the welfare of plants. Its sturdy frame supports a number of shanks which, depending on type, may reach a depth of up to 40 cm.

Der Tiefenlockerer für Weinberge ist eine Maschine, die hauptsächlich für Weinberge und Obstplantagen entwickelt wurde. Der Tiefenlockerer hält die Erdoberfläche unverändert und beseitigt zugleich die Sohlen vorheriger Bearbeitungen bzw. die Bodenverdichtungen, die infolge der ständigen Durchfahrt von Maschinen entstehen, was die Wasserdurchlässigkeit des Bodens und das Wohlergehen der Pflanzen erheblich erhöht. Am robuste Rahmen sind Zinken angebracht, die je nach Typologie bis zu einer Tiefe von 40 cm reichen können.

El descompactador para viñedos es una máquina diseñada principalmente para viñedos y huertos que permite mantener intacta la superficie del suelo y al mismo tiempo eliminar la capa compactada por el tránsito constante de la maquinaria, lo que aumenta enormemente la capacidad de drenaje y el bienestar de las plantas. En el bastidor resistente se pueden montar brazos que pueden alcanzar, según el tipo, hasta 40 cm de profundidad.

Le décompacteur vigneron est essentiellement conçu pour les vignes et les vergers et respecte la surface du terrain tout en éliminant la semelle de labour ou le compactage entraîné par un passage constant des machines, ce qui renforce considérablement les capacités de drainage du sol et le bien-être des plantes. Son bâti robuste accueille des dents pouvant atteindre 40 cm de profondeur en fonction leur type.

DCV



2050622  
**On request**  
 Kit concimazione localizzata 400 litri  
 400 liters localised fertilisation kit  
 Satz für lokalisierte Düngung 400 Liter  
 Kit abonadora con localizador 400 litros  
 Kit épandage localisé 400 litres

2050677  
**On request**  
 Kit rullo a gabbia. Solo per versione DCV-VARIO.  
 Cage roller kit. Only for DCV-VARIO model.  
 Satz Rohrstabwalze. Nur für Version DCV-VARIO.  
 Kit rodillo de jaula. Solo para versión DCV-VARIO.  
 Kit rouleau cage. Version DCV-VARIO uniquement.

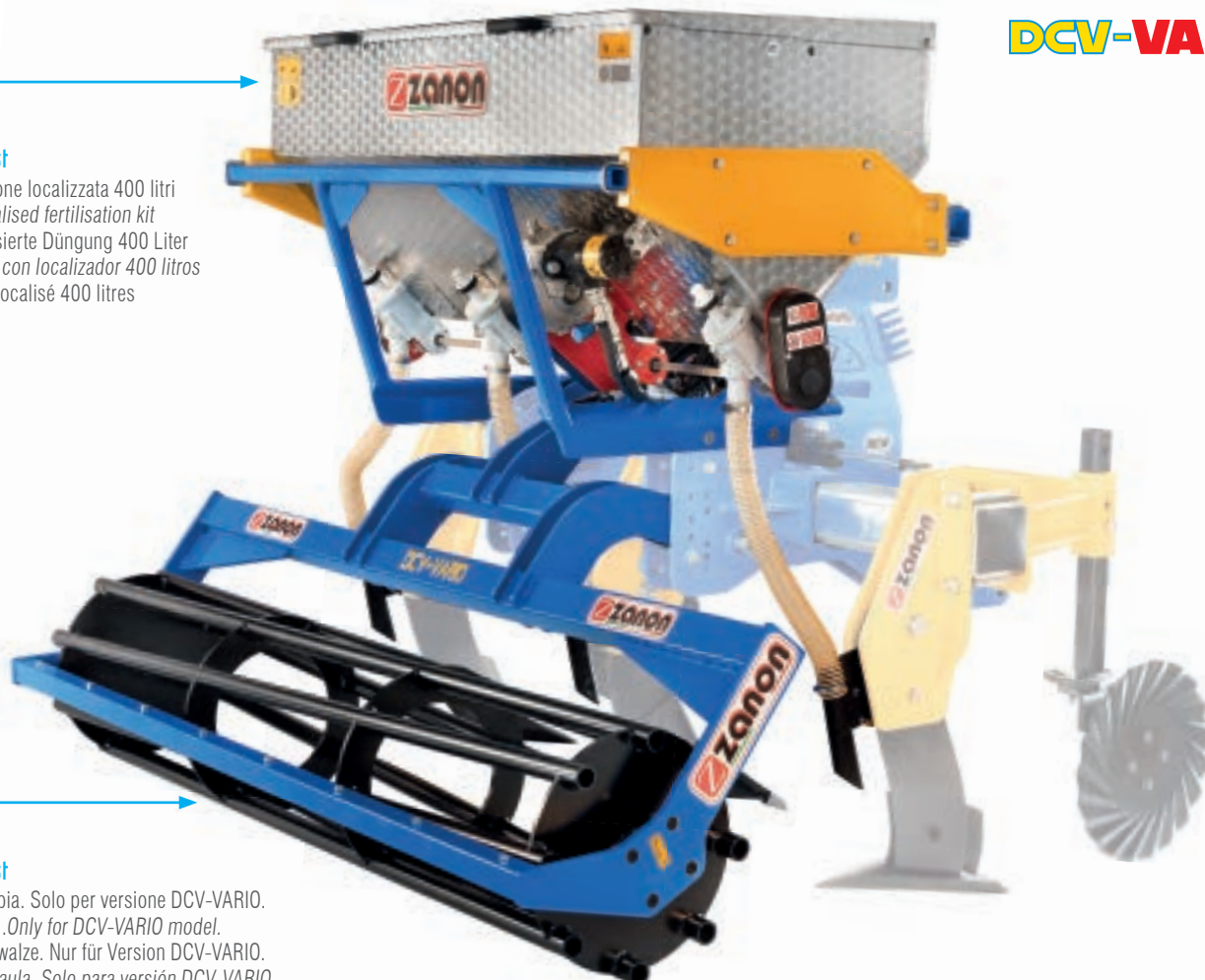

DCV-VARIO

L'immagine della macchina è indicativa. Gli utensili e gli accessori sono a richiesta.  
 The picture of the machine is indicative. Tools and accessories are on request.





## UTENSILI





WORKING TOOLS  
WERKZEUGE  
HERRAMIENTAS DE TRABAJO  
OUTILS DE TRAVAIL





## DCV-VARIO





## DCV-F

DCV UTENSILI

Kit disco aprisolco piroettante frontale	Kit pivoting front disc	Kit Schwenkbare Frontscheiben	Kit disco abresurco delanteros giratorios	Kit disque brise-mottes pivotant
				
cod.	Ø cm	cm	kg	euro
2050617 DX	43	85	40	890,00
2050618 SX	43	85	40	890,00

Kit ancora centrale per profondità fino a 40 cm	Central anchor kit for depths up to 40 cm	Kit mittlerer zinken für tiefen bis zu 40 cm	Kit punta central para profundidad de hasta 40 cm	Kit dent centrale pour profondeurs jusqu'à 40 cm
				
cod.	cm	cm	kg	euro
2050623	8	88	56	590,00

Kit talpa aprisolco	Kit soil opener	Kit bodenöffner	Kit abresurco	Kit ouvreur de sol
				
cod.	cm	Ø cm	kg	euro
2050678	25	9	8	380,00

Kit rullo liscio completo di telaio	Kit smooth roller with frame	Kit Glatte walze mit Rahmen	Kit rodillo liso con marco	Kit rouleau lisses avec châssis
				
cod.	cm	Ø cm	kg	euro
2050619	140	41	270	2.200,00
2050620	160	41	285	2.350,00
2050621	180	41	300	2.500,00

DCV-VARIO	DCV-F	SOIL LOOSENER FOR VINEYARD
DCV-VARIO	DCV-F	TIEFENLOCKERER FÜR WEINBERGE
DCV-VARIO	DCV-F	DESCOMPACTADOR VIÑEDO
DCV-VARIO	DCV-F	DÉCOMPACTEUR VIGNERON



# UTENSILI

## WORKING TOOLS

## WERKZEUGE

## HERRAMIENTAS DE TRABAJO

## OUTILS DE TRAVAIL

# DCV-VARIO

# DCV-F

**NEW**

Kit doppio mini rullo con regolazione meccanica	Kit double mini roller with mechanical adjustment	Kit Doppel-Minirolle mit mechanischer Einstellung	Kit doble mini rodillo con ajuste mecánico	Kit double mini rouleau avec réglage mécanique	
	cod.	cm	Ø cm	kg	euro
	2050873	(2x) 47	41	245	2.350,00

Kit per la regolazione idraulica del rullo	Kit for hydraulic roller adjustment	Kit hydraulische verstellung heckwalze	Kit para la regulación hidráulica de rodillo	Kit pour la régulation hydraulique de rouleau		
	cod.	cm	Ø cm	Ø cm	kg	euro
	2050624	20	70	30	10	380,00

Kit concimazione localizzata 400 litri	400 liters localised fertilisation kit	Satz für lokalisierte düngung 400 Liter	Kit abonadora con localizador 400 litros	Kit épandage localisé 400 litres		
	cod.	lt	cm	cm	kg	euro
	2050622	400	140x70	62	130	5.890,00
Solo per versione DCV-VARIO - Only DCV-VARIO model - Nur version DCV-VARIO Solo versión DCV-VARIO - Version DCV-VARIO uniquement						

Kit rullo a gabbia completo di telaio	Kit cage roller with frame	Kit Stabwalze mit Rahmen	Kit rodillo de jaula con marco	Kit rouleau barre avec châssis	
	cod.	cm	Ø cm	kg	euro
	2050652	180	43		3.190,00
Solo per versione DCV-VARIO - Only DCV-VARIO model - Nur version DCV-VARIO Solo versión DCV-VARIO - Version DCV-VARIO uniquement					

## VERSIONE SINGOLA

SINGLE VERSION

EINZELVERSION





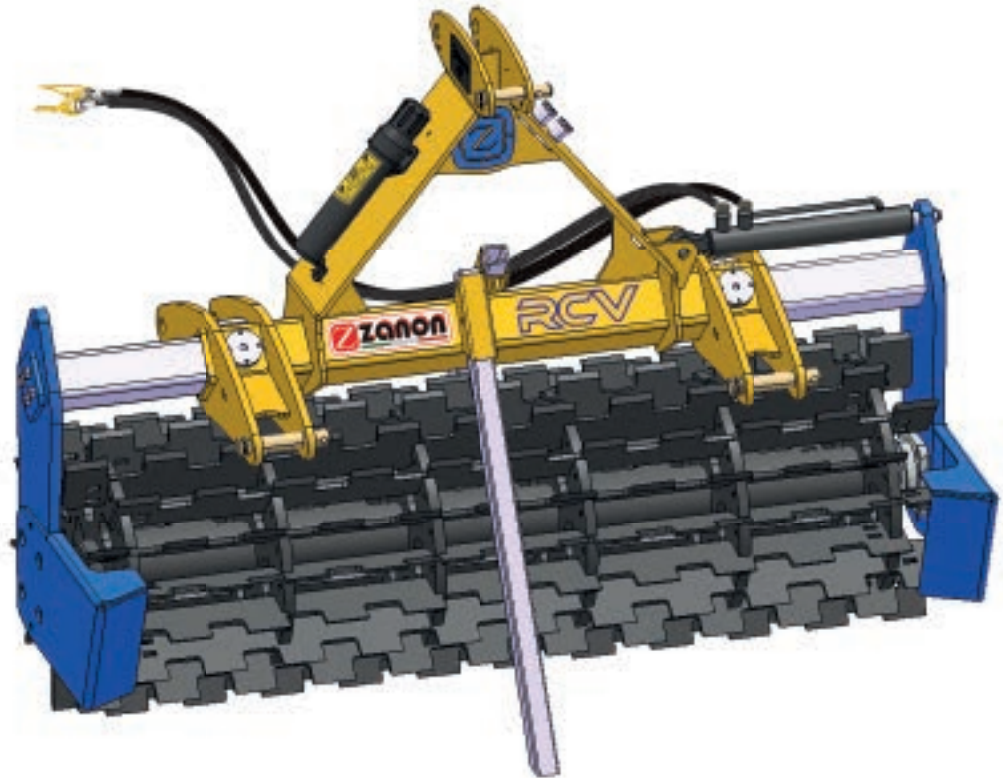
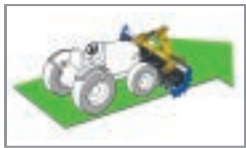

VERSIÓN INDIVIDUAL

VERSION SIMPLE

**NEW**



Impiego	Use	Verwendung	Uso	Utilisation
<p>Il rullo pacciamatore è composto da lame in acciaio antiusura ed è progettato per piegare e incidere i fili d'erba nelle colture di copertura in vigneti e frutteti. Questo tipo di lavorazione crea una "coperta vegetale" naturale che favorisce l'apporto microbiologico al terreno proteggendolo dalla siccità e migliorando il bilancio idrologico delle piante coltivate.</p>	<p>The mulching roller consists of wear-resistant steel blades and is designed to bend and cut blades of grass in cover crops in vineyards and orchards. This type of working creates a natural 'plant blanket' that promotes the microbiological supply to the soil, protecting it from drought and improving the hydrological balance of the cultivated plants.</p>	<p>Die Mulchwalze besteht aus verschleißfesten Stahlklingen und ist zum Biegen und Schneiden von Grashalmen in Deckkulturen in Weinbergen und Obstplantagen bestimmt. Durch diese Art der Bearbeitung entsteht eine natürliche "Pflanzendecke", die die mikrobiologische Versorgung des Bodens fördert, ihn vor Trockenheit schützt und den Wasserhaushalt der angebauten Pflanzen verbessert.</p>	<p>El rodillo para cubrición del suelo consta de cuchillas de acero resistentes al desgaste y está diseñado para doblar y cortar las hojas de hierba de los cultivos de cobertura en viñedos y huertos. Este tipo de trabajo crea una "manta vegetal" natural que favorece el aporte microbiológico al suelo, protegiéndolo de la sequía y mejorando el equilibrio hidrológico de las plantas cultivadas.</p>	<p>Le rouleau de paillage est constitué de lames en acier résistant à l'usure et est conçu pour plier et couper les brins d'herbe des cultures de couverture dans les vignobles et les vergers. Ce type de travail crée une "couverture végétale" naturelle qui améliore l'apport microbiologique au sol, le protégeant de la sécheresse et améliorant l'équilibre hydrologique des plantes cultivées.</p>

MOD							
mod.	cod.	HP	cm	cm	cm	kg	euro
<b>RCV 150</b>	1003981	30 - 120	155	52 - 102	162×60×118	480	<b>6.300,00</b>
<b>RCV 170</b>	1003982	30 - 120	175	62 - 112	182×60×118	540	<b>6.600,00</b>
<b>RCV 190</b>	1003983	30 - 120	195	72 - 122	202×60×118	600	<b>6.900,00</b>

Di serie	Standard equipment	Serienmässig	Estándar	De série	
<ul style="list-style-type: none"> <li>Attacco a 3 punti reversibile cat. II</li> <li>Lame intercambiabili in Hardox</li> <li>Convogliatori laterali</li> <li>Pattini di scorrimento</li> <li>Protezioni antinfortunistiche conformi alla normativa CE</li> </ul>	<ul style="list-style-type: none"> <li>Reversible 3-point linkage cat. II</li> <li>Interchangeable Hardox blades</li> <li>Side conveyors</li> <li>Sliding pads</li> <li>Protective equipment as per EC safety rules</li> </ul>	<ul style="list-style-type: none"> <li>Umkehrbare 3-Punkt-Anbau Kat. II</li> <li>Auswechselbare Hardox-Klingen</li> <li>Seitenförderer</li> <li>Gleitende Pads</li> <li>Unfallschutz nach EU-Vorschriften</li> </ul>	<ul style="list-style-type: none"> <li>Enganche a 3 punto reversibile cat. II</li> <li>Cuchillas intercambiables en Hardox</li> <li>Transportadores laterales</li> <li>Patines de deslizamiento</li> <li>Protecciones de seguridad de acuerdo con la norma CE</li> </ul>	<ul style="list-style-type: none"> <li>Attelage 3 points réversible cat. II</li> <li>Lames interchangeables en Hardox</li> <li>Convoyeurs latéraux</li> <li>Patins de glissement</li> <li>Protections contre les accidents aux normes CE</li> </ul>	
cod.	A richiesta	On request	Auf Anfrage	Opcionales	Sur demande
2051403	Kit spostamento idraulico 25 cm	Kit hydraulic side shift 25 cm	Kit hydraulische Verschiebung 25 cm	Kit desplazador hidráulico 25 cm	Kit de déplacement lat. hydr. 25 cm
2051405	Serbatoio zavorra	Ballast tank	Ballast-Tank	Tanque de lastre	Réservoir de lestage

RCV	MULCHING ROLLER FOR VINEYARDS AND ORCHARDS
RCV	MULCHWALZE FÜR WEINBERGE UND OBSTPLANTAGEN
RCV	RODILLOS PARA CUBRICIÓN DEL SUELO EN VIÑEDOS Y HUERTOS
RCV	ROULEAU DE PAILLAGE POUR VIGNOBLES ET VERGERS



## VERSIONE DOPPIA

DOUBLE VERSION

DOPPELTE VERSION

VERSIÓN DOBLE

VERSION DOUBLE

**NEW**

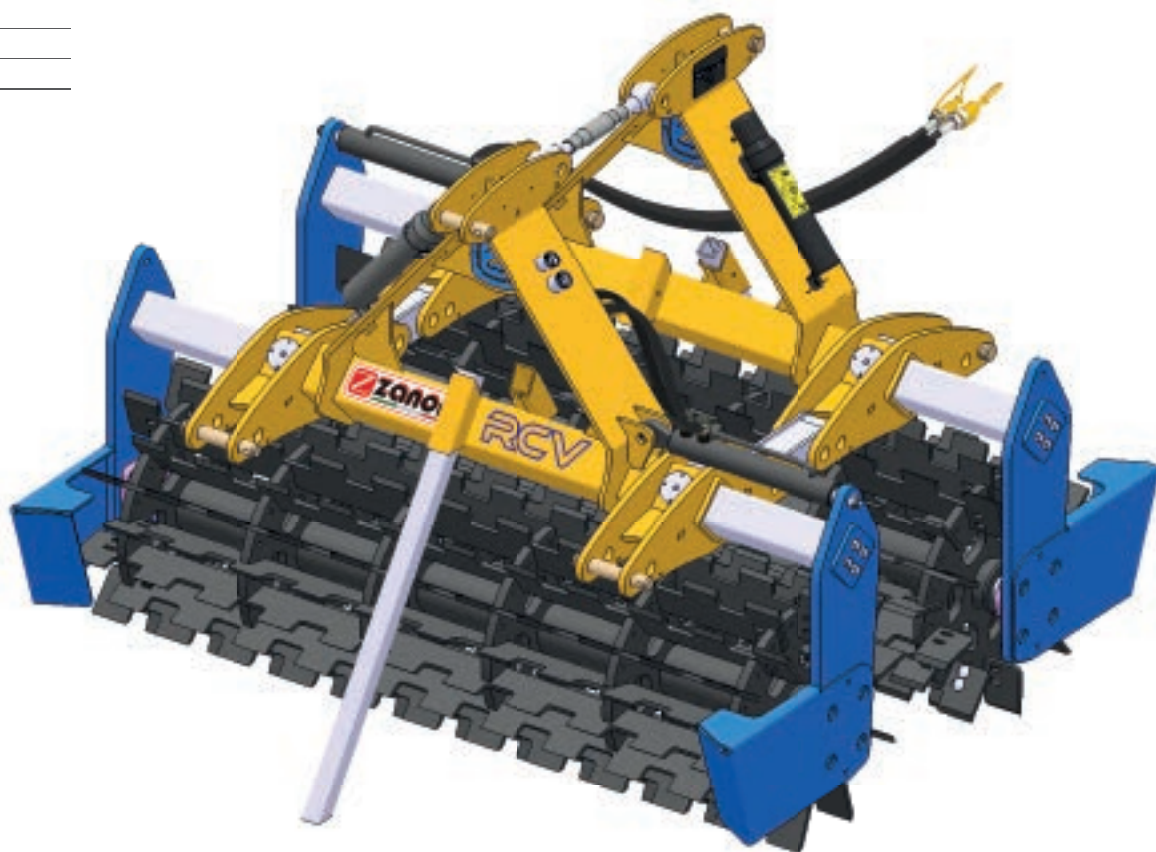

RCV

In entrambe le versioni, a 1 o 2 rulli, la macchina può lavorare sia in posizione anteriore che posteriore al senso di marcia del trattore e, grazie allo spostamento laterale, permette di coprire totalmente la superficie da trattare ottimizzando i passaggi tra le file.

In both versions, with 1 or 2 rollers, the machine can work either front or rear of the tractor's direction and, thanks to its side displacement, can allow the area to be fully covered, optimising the passages between rows.

In beiden Versionen, mit 1 oder 2 Walzen, kann die Maschine entweder vorne oder hinten in Fahrtrichtung des Traktors arbeiten und ermöglicht dank ihrer seitlichen Verschiebung eine vollständige Abdeckung der zu bearbeitenden Fläche, wodurch den Übergang zwischen den Reihen optimiert wird.

En sus dos versiones, con 1 ó 2 rodillos, la máquina puede trabajar tanto en la parte delantera como en la trasera del sentido de marcha del tractor y, gracias a su desplazamiento lateral, permite cubrir totalmente la superficie a tratar, optimizando los pasos entre hileras.

Dans les deux versions, avec 1 ou 2 rouleaux, la machine peut travailler à l'avant ou à l'arrière du sens de marche du tracteur et, grâce à son déplacement latéral, permet de couvrir entièrement la surface à traiter, en optimisant les passages entre les rangs.

MOD							
mod.	cod.	HP	cm	cm	cm	kg	euro
<b>RCV 150 doppia</b>	1003984	60 - 120	135 - 205	102 - 102	162×120×118	960	<b>11.600,00</b>
<b>RCV 170 doppia</b>	1003985	60 - 120	175 - 225	112 - 112	182×120×118	1080	<b>12.200,00</b>
<b>RCV 190 doppia</b>	1003986	60 - 120	195 - 245	122 - 122	202×120×118	1200	<b>12.800,00</b>

Di serie	Standard equipment	Serienmässig	Estándar	De série	
<ul style="list-style-type: none"> <li>Attacco a 3 punti reversibile cat. II</li> <li>Lame intercambiabili in Hardox</li> <li>Convogliatori laterali</li> <li>Pattini di scorrimento</li> <li>Protezioni antinfortunistiche conformi alla normativa CE</li> </ul>	<ul style="list-style-type: none"> <li>Reversible 3-point linkage cat. II</li> <li>Interchangeable Hardox blades</li> <li>Side conveyors</li> <li>Sliding pads</li> <li>Protective equipment as per EC safety rules</li> </ul>	<ul style="list-style-type: none"> <li>Umkehrbare 3-Punkt-Anbau Kat. II</li> <li>Auswechselbare Hardox-Klingen</li> <li>Seitenförderer</li> <li>Gleitende Pads</li> <li>Unfallschutz nach EU-Vorschriften</li> </ul>	<ul style="list-style-type: none"> <li>Enganche a 3 punto reversibile cat. II</li> <li>Cuchillas intercambiables en Hardox</li> <li>Transportadores laterales</li> <li>Patines de deslizamiento</li> <li>Protecciones de seguridad de acuerdo con la norma CE</li> </ul>	<ul style="list-style-type: none"> <li>Attelage 3 points réversible cat. II</li> <li>Lames interchangeables en Hardox</li> <li>Convoyeurs latéraux</li> <li>Patins de glissement</li> <li>Protections contre les accidents aux normes CE</li> </ul>	
cod.	A richiesta	On request	Auf Anfrage	Opcionales	Sur demande
2051404	Kit spostamento idraulico 25 cm	Kit hydraulic side shift 25 cm	Kit hydraulische Verschiebung 25 cm	Kit desplazador hidráulico 25 cm	Kit de déplacement lat. hydr. 25 cm
2051405	Serbatoio zavorra	Ballast tank	Ballast-Tank	Tanque de lastre	Réservoir de lestage



**Standard equipment**

Scambiatore di calore  
Heat exchanger  
Wärmetauscher  
Intercambiador térmico  
Échangeur de chaleur

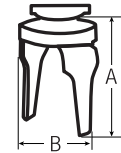

Ø A  
180 mm

Ø B  
155 mm

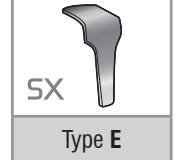
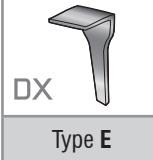

**Standard equipment**

Joystick multifunzione  
Multifunction joystick  
Multifunktions-joystick  
Joystick multifunción  
Joystick multifonction

MOD										
mod.	cod.	HP	rpm/min	type	nr	cm	cm	kg	euro	
ITE	1003149	30 - 60	540	T-40	5 + 5 (dx+sx)	40 - 60 - 80 - 100	152×140×130	525	14.950,00	

Di serie	Standard equipment	Serienmässig	Estándar	De série
<ul style="list-style-type: none"> <li>Attacco a 3 punti Cat. II</li> <li>Joystick multifunzione</li> <li>Comando di emergenza</li> <li>Ruote di appoggio con cresta regolabili in altezza</li> <li>Pianto oleodinamico completo di serbatoio, sistema filtrante e scambiatore di calore</li> <li>Regolazione dell'inclinazione della testata per la registrazione dell'angolo di lavoro</li> <li>Protezioni antinfortunistiche conformi alla normativa CE</li> </ul>	<ul style="list-style-type: none"> <li>3-point linkage cat. II</li> <li>Multifunction Joystick</li> <li>Emergency control</li> <li>Height-adjustable crest wheels</li> <li>Hydraulic system complete with tank, filter system and heat exchanger</li> <li>Head tilt adjustment for working angle adjustment</li> <li>Protective equipment as per EC safety rules</li> </ul>	<ul style="list-style-type: none"> <li>3-Punkt-Anbau Kat. II</li> <li>Multifunktions-Joystick</li> <li>Notfallsteuerung</li> <li>Höhenverstellbare Räder mit Führung</li> <li>Hydraulisches System komplett mit Tank, Filtersystem und Wärmetauscher</li> <li>KopfNeigungsverstellung zur Einstellung des Arbeitswinkels</li> <li>Unfallschutz nach EU-Vorschriften</li> </ul>	<ul style="list-style-type: none"> <li>Enganche a 3 punto Cat. II</li> <li>Joystick multifunción</li> <li>Comando de emergencia</li> <li>Rueda de apoyo con regulación en altura</li> <li>Kit de centralita hidráulica completa de depósito, sistema filtrante e intercambiador de calor</li> <li>Ajuste de la inclinación de la herramienta para ajustar el ángulo de trabajo</li> <li>Protecciones de seguridad de acuerdo con la norma CE</li> </ul>	<ul style="list-style-type: none"> <li>Attelage 3 points Cat. II</li> <li>Joystick multifonction</li> <li>Commande d'urgence</li> <li>Roues de support avec guide réglables en hauteur</li> <li>Système hydraulique complet avec réservoir, système de filtrage et échangeur de chaleur</li> <li>Réglage de l'angle de la tête pour ajuster l'angle de travail</li> <li>Protections contre les accidents aux normes CE</li> </ul>



ITE	INTER-ROW ITE - POWER HARROW
ITE	UNTERSTOCKGERÄT ITE - KREISELEGGE
ITE	INTERCEPAS ITE - GRADA
ITE	INTERCEPS ITE - HERSE ROTATIVE



ORIGINAL MADE IN ITALY

MOVEMENT MACHINE

MOD		
mod.	min. cm	max. cm
ITE	94	160

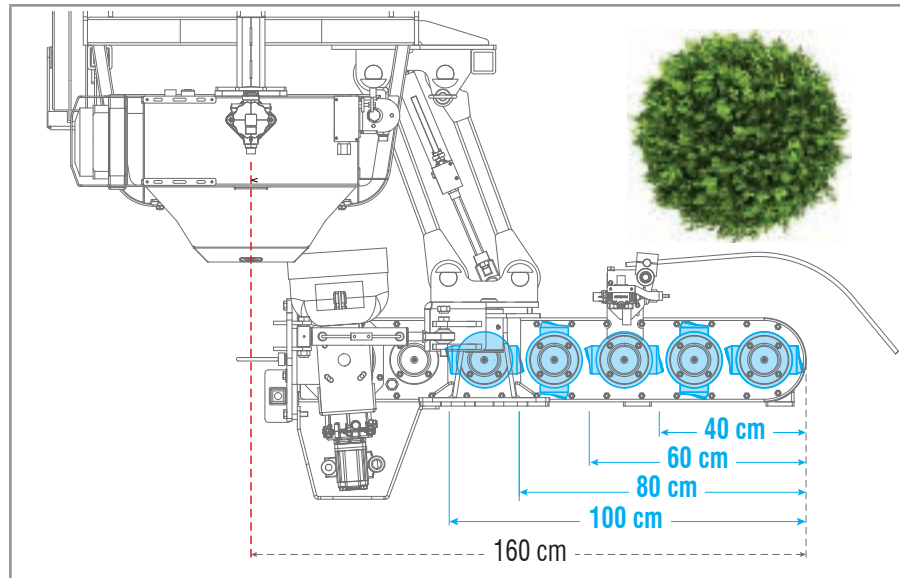

Regolazione della testata per la registrazione dell'inclinazione di lavoro  
 Adjustment of the head for setting the working depth  
 Einstellung des Kopfes für die Einstellung der Arbeitstiefe  
 Ajuste de cabezal para la regulación profundidad  
 Reglage de la tête pour la profondeur de travail

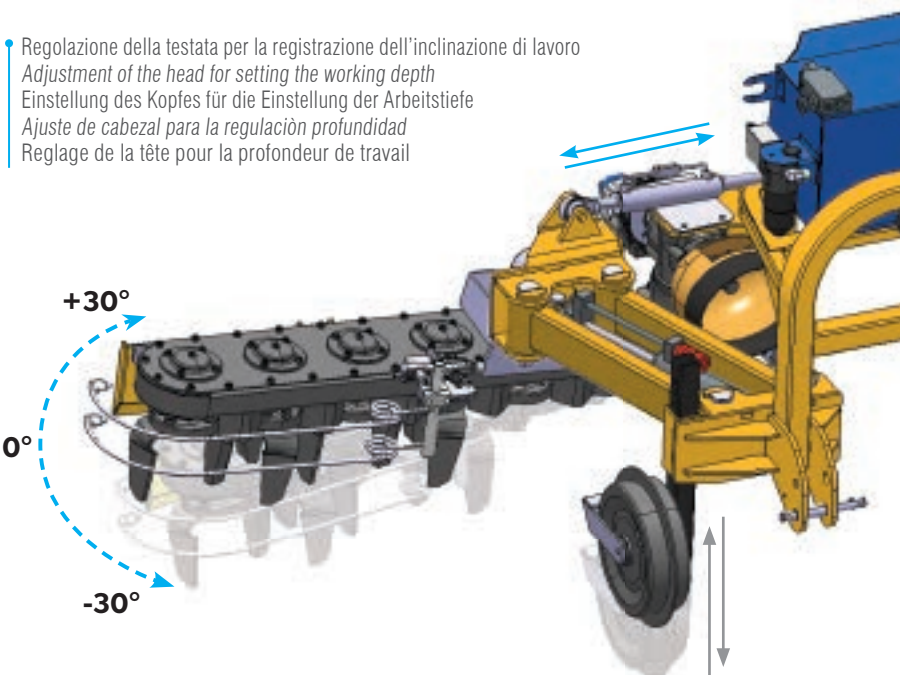

Ruote di appoggio con cresta regolabili in altezza  
 Height-adjustable crest wheels  
 Höhenverstellbare Räder mit Führung  
 Rueda de apoyo con regulación en altura  
 Roues de support avec guide réglables en hauteur

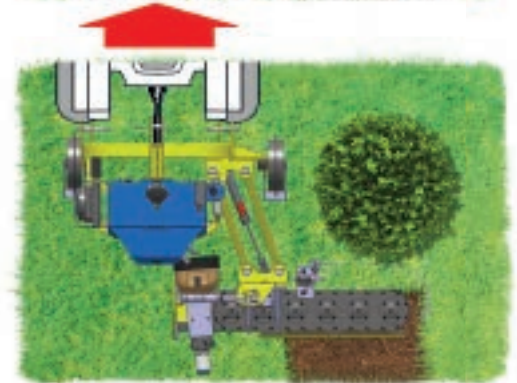
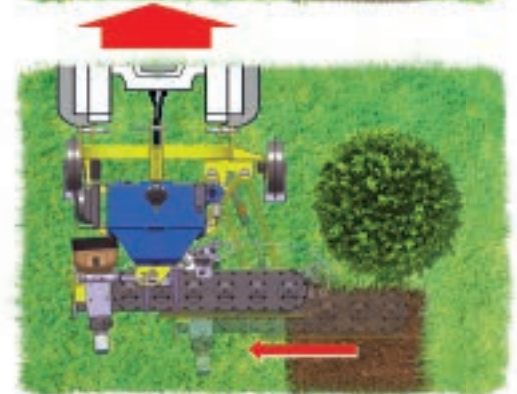
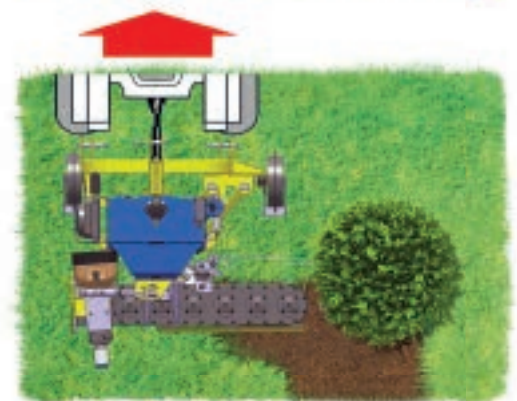

ITE

cod.	A richiesta	On request	Auf Anfrage	Opcionales	Sur demande	€
5130014	Cardano T-40	PTO shaft T-40	Gelenkwelle T-40	Cardán T-40	Cardan T-40	346,50

cod.	Ricambi	Spare parts	Ersatzteile	Recambios	Pièces de rechange
5350198	Dente ITC/E L180 - destro	Utensils ITC/E L180 - right	Werkzeug ITC/E L180 - Recht	Utensilios ITC/E L180 - derecho	Utensils ITC/E L180 - droite
5350199	Dente ITC/E L180 - sinistro	Utensils ITC/E L180 - left	Werkzeug ITC/E L180 - Link	Utensilios ITC/E L180 - izquierdo	Utensils ITC/E L180 - gauche



**Standard equipment**

Scambiatore di calore  
Heat exchanger  
Wärmetauscher  
Intercambiador térmico  
Échangeur de chaleur



**Standard equipment**

Joystick multifunzione  
Multifunction joystick  
Multifunktions-joystick  
Joystick multifunción  
Joystick multifonction

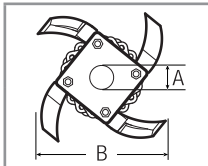

Ø A  
**60 mm**  
Ø B  
**380 mm**

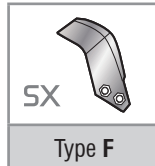
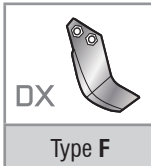

MOD									
mod.	cod.	HP	rpm/min	type	cm	cm	cm	kg	euro
<b>ITF-60</b>	1003712	30	540	T-50/T-60	60	60	144×142×130	510	<b>13.020,00</b>
<b>ITF-80</b>	1003713	40	540	T-50/T-60	80	80	164×142×130	535	<b>13.360,00</b>
<b>ITF-100</b>	1003714	50	540	T-50/T-60	100	100	184×142×130	560	<b>13.800,00</b>

Di serie	Standard equipment	Serienmässig	Estándar	De série
<ul style="list-style-type: none"> <li>Attacco a 3 punti Cat. I-II</li> <li>Ruote di appoggio con cresta regolabili in altezza</li> <li>Spostamento laterale idraulico apertura/chiusura registrabile</li> <li>Regolazione dell'inclinazione della testata per la registrazione dell'angolo di lavoro</li> <li>Impianto oleodinamico completo di serbatoio, sistema filtrante</li> <li>Scambiatore di calore</li> <li>Protezioni antinfortunistiche conformi alla normativa CE</li> </ul>	<ul style="list-style-type: none"> <li>3-point linkage cat. I-II</li> <li>Height-adjustable crest wheels</li> <li>Adjustable hydraulic side shift opening/closing</li> <li>Head tilt adjustment for working angle adjustment</li> <li>Hydraulic system complete with tank and filtering system</li> <li>Heat exchanger</li> <li>Protective equipment as per EC safety rules</li> </ul>	<ul style="list-style-type: none"> <li>3-Punkt-Anbau Kat. I-II</li> <li>Höhenverstellbare Räder mit Führung</li> <li>Einstellbarer hydraulischer Seitenverschiebung öffnen/schließen</li> <li>KopfNeigungsverstellung zur Einstellung des Arbeitswinkels</li> <li>Hydrauliksystem komplett mit Tank und Filtersystem</li> <li>Wärmetauscher</li> <li>Unfallschutz nach EU-Vorschriften</li> </ul>	<ul style="list-style-type: none"> <li>Enganche a 3 punto Cat. I-II</li> <li>Rueda de apoyo con regulación en altura</li> <li>Desplazamiento lateral hidráulico regulable en apertura/cierre</li> <li>Ajuste de la inclinación de la herramienta para ajustar el ángulo de trabajo</li> <li>Equipo hidráulico, completo de depósito de aceite y filtro</li> <li>Intercambiador térmico</li> <li>Protecciones de seguridad de acuerdo con la norma CE</li> </ul>	<ul style="list-style-type: none"> <li>Attelage 3 points Cat. I-II</li> <li>Roues de support avec guide réglables en hauteur</li> <li>Déplacement latéral hydraulique réglable ouverture/fermeture</li> <li>Réglage de l'angle de la tête pour ajuster l'angle de travail</li> <li>Système hydraulique complet avec réservoir, système de filtrage</li> <li>Échangeur de chaleur</li> <li>Protections contre les accidents aux normes CE</li> </ul>

ITF	INTER-ROW ROTARY TILLER
ITF	UNTERSTOCKGERÄT ITF - KREISELEGGE
ITF	INTERCEPAS ITF - GRADA
ITF	INTERCEPS ITF - HERSE ROTATIVE

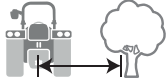
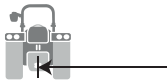

ORIGINAL MADE IN ITALY

MOVEMENT MACHINE		
MOD		
mod.	min. cm	max. cm
<b>ITF-60</b>	86	150
<b>ITF-80</b>	106	170
<b>ITF-100</b>	126	190

Regolazione della testata per la regolazione dell'inclinazione di lavoro  
 Adjustment of the head for setting the working depth  
 Einstellung des Kopfes für die Einstellung der Arbeitstiefe  
 Ajuste de cabezal para la regulación profundidad  
 Reglage de la tête pour la profondeur de travail

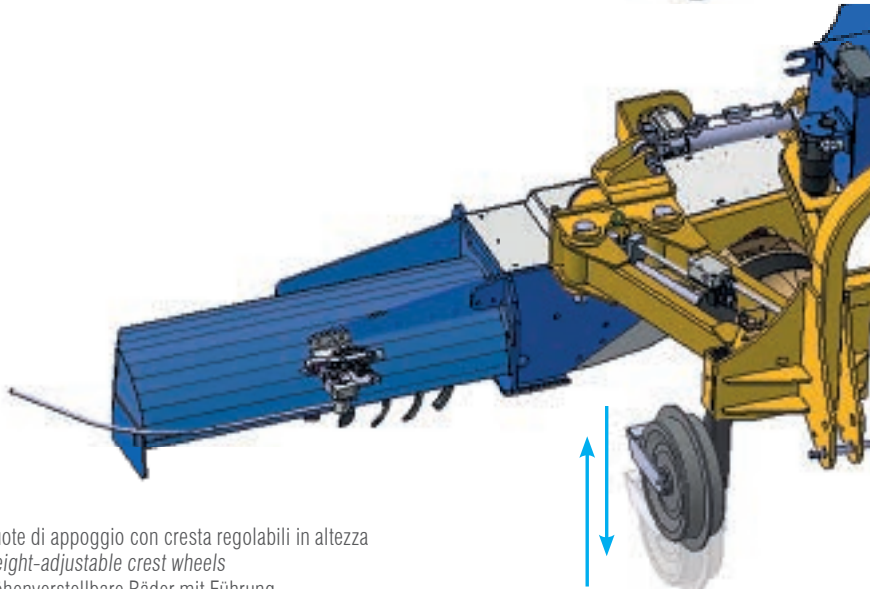
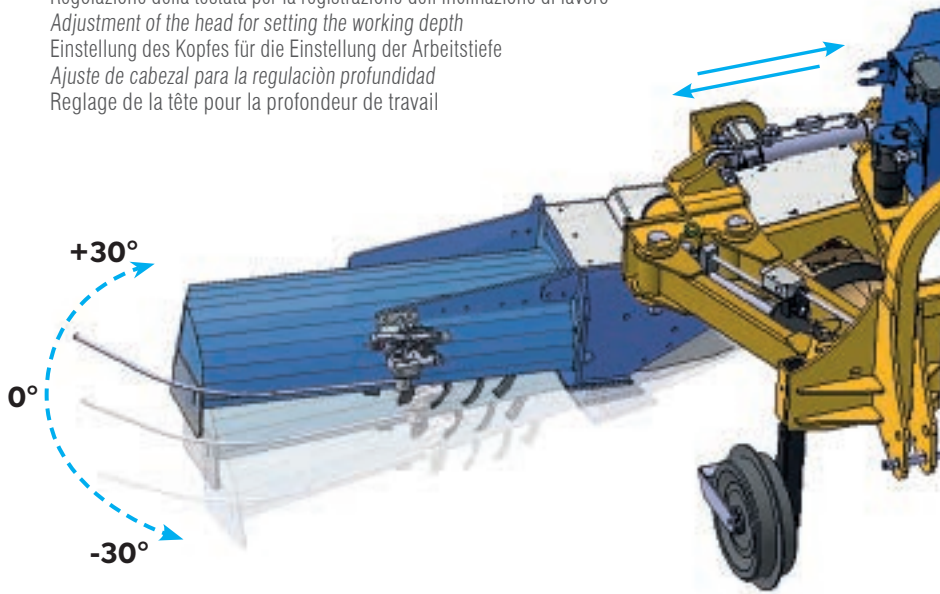

Ruote di appoggio con cresta regolabili in altezza  
 Height-adjustable crest wheels  
 Höhenverstellbare Räder mit Führung  
 Rueda de apoyo con regulación en altura  
 Roues de support avec guide réglables en hauteur

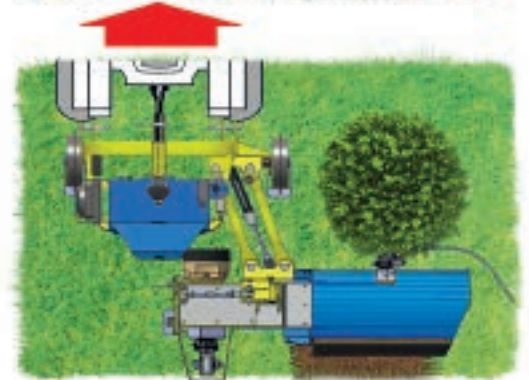
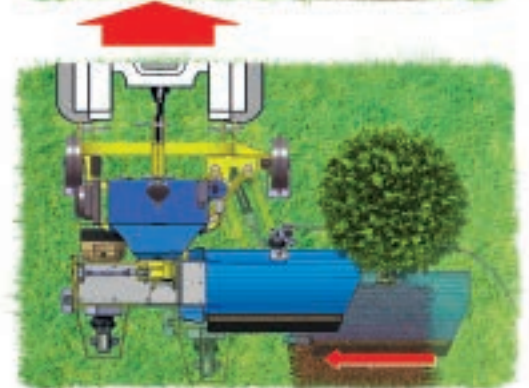
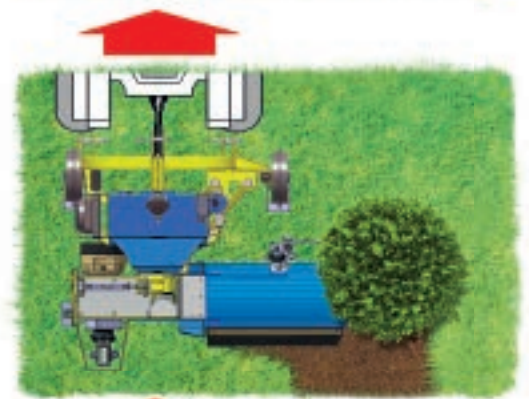
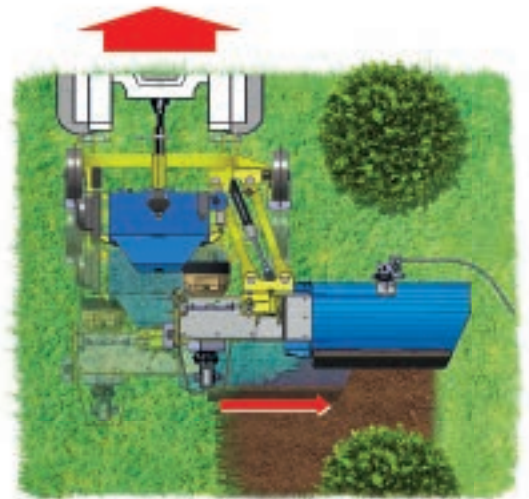

cod.	A richiesta	On request	Auf Anfrage	Opcionales	Sur demande	€
5130005	Cardano T-50	PTO shaft T-50	Gelenkwelle T-50	Cardán T-50	Cardan T-50	273,00
5130009	Cardano T-60	PTO shaft T-60	Gelenkwelle T-60	Cardán T-60	Cardan T-60	300,00

cod.	Ricambi	Spare parts	Ersatzteile	Recambios	Pièces de rechange
5350209	Zappa ITC/F - destro	Utensils ITC/F - right	Werkzeug ITC/F - Recht	Utensillos ITC/F - derecho	Utensils ITC/F - droite
5350210	Zappa ITC/F - sinistro	Utensils ITC/F - left	Werkzeug ITC/F - Link	Utensillos ITC/F - izquierdo	Utensils ITC/F - gauche

UTENSILI vedere a pag. 256

TOOLS see page 256







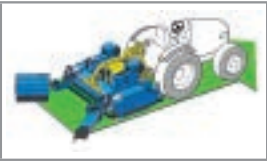

WERKZEUGE siehe Seite 256

HERRAMIENTAS ver página 256

OUTILS voir page 256



L'immagine della macchina è indicativa. Gli utensili e gli accessori sono a richiesta. – The picture of the machine is indicative. Tools and accessories are on request.

MOD									
mod.	cod.	cod.	HP	rpm/min	type	nr (type)	cm	kg	euro
<b>TDR 1400</b>	1002987	1002981	35 - 70	540/1000 *	T-60+RL	(4) SPB 1525	140×169×102	680	<b>9.740,00</b>
<b>TDR 1600</b>	1002988	1002982	40 - 70	540/1000 *	T-60+RL	(4) SPB 1525	160×169×102	750	<b>10.040,00</b>
<b>TDR 1800</b>	1002989	1002983	50 - 70	540/1000 *	T-60+RL	(6) SPB 1525	180×169×102	820	<b>10.290,00</b>
<b>TDR 2000</b>	1002990	1002984	60 - 90	540/1000 *	T-70+RL	(6) SPB 1525	200×169×102	890	<b>10.500,00</b>
<b>TDR 2200</b>	1002991	1002985	70 - 90	540/1000 *	T-70+RL	(6) SPB 1525	220×169×102	960	<b>10.870,00</b>
<b>TDR 2400</b>	1002992	1002986	80 - 100	540/1000 *	T-70+RL	(6) SPB 1525	240×169×102	1030	<b>11.230,00</b>
<b>TDR 2600</b>	1003000	1002997	90 - 130	540/1000 *	T-80+RL	(8) SPB 1525	260×169×102	1100	<b>11.400,00</b>
<b>TDR 2800</b>	1003001	1002998	90 - 130	540/1000 *	T-80+RL	(8) SPB 1525	280×169×102	1170	<b>11.650,00</b>
<b>TDR 3000</b>	1003002	1002999	110 - 150	540/1000 *	T-80+RL	(8) SPB 1525	300×169×102	1240	<b>11.980,00</b>

(\*): 540 rpm/min standard, 1000 rpm/min con scatola dedicata - 1000 rpm/min with dedicated box - 1000 rpm/min Mit dedizierter Box - 1000 rpm/min con caja dedicada - 1000 rpm/min avec boîte dédiée

Di serie	Standard equipment	Serienmässig	Estándar	De série
<ul style="list-style-type: none"> <li>Telaio con doppia lamiera</li> <li>Scatola di trasmissione senza ruota libera PTO 1 3/8" Z6</li> <li>Cardano con ruota libera</li> <li>Rotore con sistema di taglio elicoidale</li> <li>Spostamento su barre cromate</li> <li>Spostamento laterale meccanico</li> <li>Singola fila di pettini rompitori</li> <li>Piastre salvabordi</li> <li>Fiancate con bordi arrotondati</li> <li>Rullo ozioso posteriore regolabile in altezza (194 mm)</li> <li>Raschiafango per pulizia rullo ozioso</li> <li>Scarico anteriore rullo ozioso</li> <li>Protezione anteriore a bandinelle e catene</li> <li>Kit ruote anteriori</li> <li>Protezioni antinfortunistiche conformi alla normativa CE</li> </ul>	<ul style="list-style-type: none"> <li>Double skinned frame</li> <li>Gearbox without freewheel clutch PTO 1 3/8" Z6</li> <li>PTO drive shaft with freewheel clutch</li> <li>Rotor with helical cutting system</li> <li>Side shift on chrome bars</li> <li>Mechanical side shift</li> <li>Single row counter-blades</li> <li>Side guards</li> <li>Sides with rounded shoulders</li> <li>Rear levelling roller height adjustable (194 mm)</li> <li>Scraper for rear levelling roller</li> <li>Discharge of the material over the levelling roller</li> <li>Front protection with metal flaps and chains</li> <li>Front wheels kit</li> <li>Protective equipment as per EC safety rules</li> </ul>	<ul style="list-style-type: none"> <li>Doppelwandiger Rahmen</li> <li>Getriebe ohne Freilauf PTO 1 3/8" Z6</li> <li>Gelenkwelle mit Freilauf clutch</li> <li>Spiralrotor</li> <li>Seitenverschiebung über Chromstangen</li> <li>Mechanische Seitenverschiebung</li> <li>1 Reihe Gegenschneide</li> <li>Platten-Kantenschutz</li> <li>Abgerundete Seiten</li> <li>Hinterer Stützwalze höhenverstellbar (194 mm)</li> <li>Walzenabstreifer</li> <li>Entladung des Materials über die Walze</li> <li>Frontschutz mit Metallklappen und Ketten</li> <li>Satz Fronträder</li> <li>Unfallschutz nach EU-Vorschriften</li> </ul>	<ul style="list-style-type: none"> <li>Interior del cuerpo de maquina, con doble chapa</li> <li>Caja de engranajes sin rueda libre TDF 1 3/8" Z6</li> <li>Transmisión cardanica con rueda libre</li> <li>Rotor con sistema de corte helicoidal</li> <li>Desplazamiento sobre tubo cromado</li> <li>Desplazamiento lateral mecánico</li> <li>Rompedor</li> <li>Placa protección bordes</li> <li>Lados con bordes redondeados</li> <li>Rodillo nivelador trasero (194 mm), con regulación en altura</li> <li>Limpiador montado en el rodillo nivelador trasero</li> <li>Descarga anterior al rodillo nivelador</li> <li>Protección delantera a placas metálicas y cadenas</li> <li>Kit de ruedas delanteras</li> <li>Protecciones de seguridad de acuerdo con la norma CE</li> </ul>	<ul style="list-style-type: none"> <li>Caisson renforcé par blindage interne</li> <li>Boîtier de transmission sans roue libre PDF 1 3/8" Z6</li> <li>Cardan avec roue libre</li> <li>Rotor avec système de coupe hélicoïdal</li> <li>Déplacement avec barre chromée</li> <li>Déport latéral mécanique</li> <li>Simple rangée de peignes</li> <li>Plaques de protection des bords</li> <li>Côtés latéraux arrondis</li> <li>Rouleau d'appui arrière réglable en hauteur (194 mm)</li> <li>Racleur pour le rouleau d'appui</li> <li>Ejection devant le rouleau d'appui</li> <li>Protection avant avec volets métalliques et chaînes</li> <li>Kit roues antérieures</li> <li>Protections contre les accidents aux normes CE</li> </ul>

<b>TDR</b>	MULCHER MEDIUM DUTY WITH DOUBLE ROTOR
<b>TDR</b>	MULCHGERÄTE: MITTELSCHWERE AUSFÜHRUNG MIT DOPPELROTOR
<b>TDR</b>	TRITURADORA DE HIERBA Y SARMIENTOS CON DOBLE RODILLO
<b>TDR</b>	BROYEUR D'HERBE ET DE SARMENTS AVEC DOUBLE ROTOR



ORIGINAL MADE IN ITALY

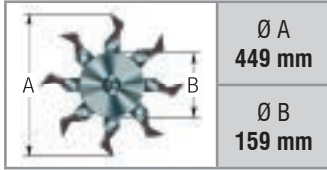

Ø A  
**449 mm**

Ø B  
**159 mm**

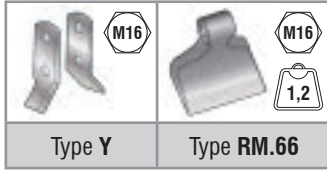

Type Y

Type RM.66

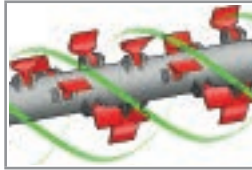

Sistema di taglio elicoidale  
Helical cutting system  
Spiralrotor  
Sistema de corte helicoidal  
Système de coupe hélicoïdal

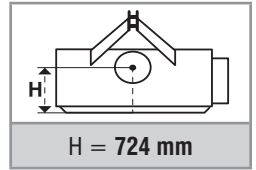

H = 724 mm

MOD	MOVEMENT MACHINE					WORKING WIDTH	Standard		On request
	cm		cm		cm		nr	nr	nr
<b>TDR 1400</b>	85	55	55	85	30	140	40	20	11
<b>TDR 1600</b>	95	65	65	95	30	160	48	24	13
<b>TDR 1800</b>	105	75	75	105	30	180	48	24	15
<b>TDR 2000</b>	120	80	80	120	40	200	56	28	17
<b>TDR 2200</b>	130	90	90	130	40	220	56	28	18
<b>TDR 2400</b>	140	100	100	140	40	240	64	32	20
<b>TDR 2600</b>	150	110	110	150	40	260	72	36	22
<b>TDR 2800</b>	160	120	120	160	40	280	72	36	23
<b>TDR 3000</b>	170	130	130	170	40	300	80	40	25

cod.	A richiesta	On request	Auf Anfrage	Opcionales	Sur demande	€
2050010	Gruppo spost. idr. 30 cm	Hydraulic side shift 30 cm	Hydraulische Verschiebung 30 cm	Kit desplazador hidr. 30 cm	Groupe de dépl. lat. 30 cm	<b>306,00</b>
2050011	Gruppo spost. idr. 40 cm	Hydraulic side shift 40 cm	Hydraulische Verschiebung 40 cm	Kit desplazador hidr. 40 cm	Groupe de dépl. lat. 40 cm	<b>315,50</b>
5210292	Aste di raccolta sarmenti	Twig rakes	Holzaufnahmezinken	Astas de cosecha	Tiges de ramassage	<b>17,60</b>
2050679	Kit ruote posteriori in acciaio fisse	Fixed steel rear wheels kit	Satz feste Stahl-Hinterräder	Kit de ruedas traseras, en hierro, fijas	Kit roues arrière fixes en acier	<b>580,00</b>
2050680	Kit slitte antiusura	Anti-wear slide kit	Anti-wear slide kit	Kit de deslizamiento antidesgaste	Kit coulissant anti-usure	<b>95,00</b>

cod.	Ricambi	Spare parts	Ersatzteile	Recambios	Pièces de rechange
5130052	Cardano T-60+RL	PTO shaft T-60+RL	Gelenkwelle T-60+RL	Cardán T-60+RL	Cardan T-60+RL
5130053	Cardano T-70+RL	PTO shaft T-70+RL	Gelenkwelle T-70+RL	Cardán T-70+RL	Cardan T-70+RL
5130054	Cardano T-80+RL	PTO shaft T-80+RL	Gelenkwelle T-80+RL	Cardán T-80+RL	Cardan T-80+RL
5354071	Cinghia SPB-1525	Cug belt SPB-1525	Keilriemen SPB-1525	Correa SPB-1525	Courroie SPB-1525
5315446	Vite M16 per utensile	M16 screw for tool	M16 Schraube für Werkzeug	Tornillo M16 para herramienta	Vis M16 pour outil
5323017	Dado M16 per utensile	M16 nut for tool	M16 Mutter für Werkzeug	Tuerca M16 para herramienta	Ecrou M16 pour outil
5350121	Mazza RM.66	Hammer RM.66	Hammer RM.66	Martillo RM.66	Marteau RM.66
5350127	Coltello "Y"	"Y" blade	"Y" Messer	Cuchilla "Y"	Couteau "Y"
2020159	Scatola trasmissione 540 giri/min.	Gear box 540 rpm	Getriebe 540 U/min.	Caja de engranajes 540 rpm	Boîtier de transm. 540 tours/min.
2020161	Scatola trasmissione 1000 giri/min.	Gear box 1000 rpm	Getriebe 1000 U/min.	Caja de engranajes 1000 rpm	Boîtier de transm. 1000 tours/min.

All'ordine specificare se la macchina lavora frontale o posteriore, n. di giri e senso di rotazione della PTO

To order, specify whether the machine works front or rear, n. of revolutions and direction of rotation of the PTO

Geben Sie bei der Bestellung an, ob die Maschine vorne oder hinten arbeitet, n. Drehzahl und Drehrichtung der Zapfwelle

Al ordenar, especifique si la máquina funciona en la parte delantera o trasera, n. de revoluciones y sentido de giro de la TDF

Pour commander spécifiez si la machine fonctionne à l'avant ou à l'arrière, n. de révolutions et sens de rotation de la prise de force

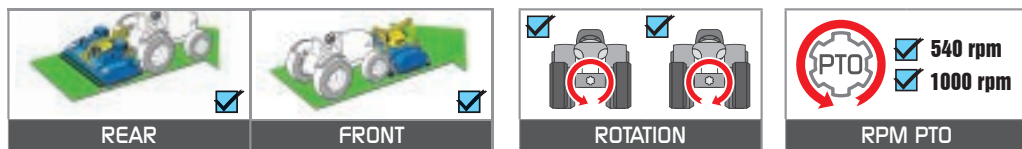

## UTENSILI

WORKING TOOLS

WERKZEUGE

HERRAMIENTAS DE TRABAJO

OUTILS DE TRAVAIL

Prima  
Before  
Vorher  
Antes  
Avant



TDR UTENSILI

### IT-PRO - Ø50 LAME





**Kit testata IT-PRO lame**  
Singola o doppia  
2 lame - Ø di lavoro 50 cm

**Kit disc-mower IT-PRO blades**  
Single or double  
2 blades - Working Ø 50 cm

**Scheibenmäher IT-PRO**  
**Messerklngen** Einzel oder Doppel  
2 Messerklngen - Arbeits-Ø 50 cm

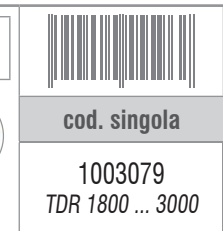
**Kit cabezal interfila IT-PRO**  
**cuchilla** Simple o doble  
2 cuchilla - Ø de trabajo 50 cm

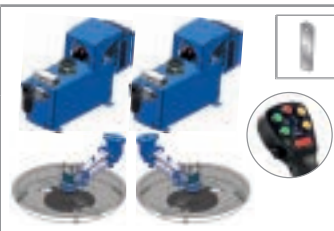
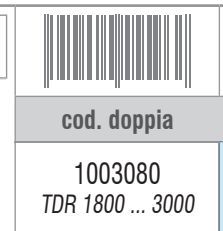
**Kit disque satellite IT-PRO**  
**lames** Simple ou double  
2 lames - Ø de travail 50 cm

		 <b>cod. singola</b>	 <b>euro</b>			 <b>cod. doppia</b>	 <b>euro</b>

### IT-PRO - Ø70 LAME





**Kit testata IT-PRO lame**  
Singola o doppia  
2 lame - Ø di lavoro 70 cm

**Kit disc-mower IT-PRO blades**  
Single or double  
2 blades - Working Ø 70 cm

**Scheibenmäher IT-PRO**  
**Messerklngen** Einzel oder Doppel  
2 Messerklngen - Arbeits-Ø 70 cm

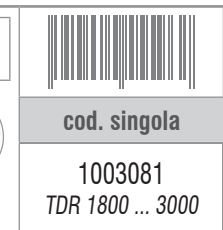
**Kit cabezal interfila IT-PRO**  
**cuchilla** Simple o doble  
2 cuchilla - Ø de trabajo 70 cm

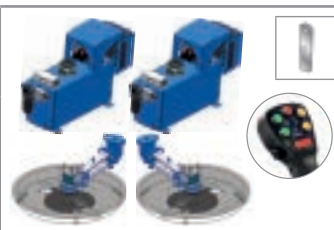
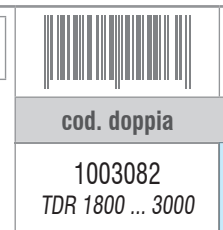
**Kit disque satellite IT-PRO**  
**lames** Simple ou double  
2 lames - Ø de travail 70 cm

		 <b>cod. singola</b>	 <b>euro</b>			 <b>cod. doppia</b>	 <b>euro</b>

### IT-PRO - Ø50 FILO

**Kit testata IT-PRO filo**  
Singola o doppia  
4 Fili (8 taglianti) Ø 6  
Ø di lavoro 50 cm

**Kit disc-mower IT-PRO wire**  
Single or double  
4 wires (8 cutting edges) Ø 6  
Working Ø 50 cm

**Kit Scheibenmäher IT-PRO**  
**Faden** Einzel oder Doppel  
4 Drähte (8 Schneidkanten) Ø 6  
Arbeits-Ø 50 c

**Kit cabezal interfila IT-PRO**  
**hilo** Simple o doble  
4 hilos (8 filos de corte) Ø 6  
Ø de trabajo 50 cm

**Kit disque satellite IT-PRO fil**  
Simple ou double  
4 fils (8 tranchants) Ø 6  
Ø de travail 50 cm

		 <b>cod. singola</b>	 <b>euro</b>			 <b>cod. doppia</b>	 <b>euro</b>

### IT-PRO - Ø70 FILO

**Kit testata IT-PRO filo**  
Singola o doppia  
4 Fili (8 taglianti) Ø 6  
Ø di lavoro 70 cm

**Kit disc-mower IT-PRO wire**  
Single or double  
4 wires (8 cutting edges) Ø 6  
Working Ø 70 cm

**Kit Scheibenmäher IT-PRO**  
**Faden** Einzel oder Doppel  
4 Drähte (8 Schneidkanten) Ø 6  
Arbeits-Ø 70 c

**Kit cabezal interfila IT-PRO**  
**hilo** Simple o doble  
4 hilos (8 filos de corte) Ø 6  
Ø de trabajo 70 cm

**Kit disque satellite IT-PRO fil**  
Simple ou double  
4 fils (8 tranchants) Ø 6  
Ø de travail 70 cm

		 <b>cod. singola</b>	 <b>euro</b>			 <b>cod. doppia</b>	 <b>euro</b>

TDR	MULCHER MEDIUM DUTY REVERSIBLE WITH DOUBLE ROTOR
TDR	MULCHGERÄTE: MITTELSCHWERE AUSFÜHRUNG MIT DOPPELROTOR
TDR	SEGADORA REVERSIBLE CON DOBLE RODILLO
TDR	TONDEUSE REVERSIBLE AVEC DOUBLE ROTOR



# UTENSILI

## WORKING TOOLS

## WERKZEUGE





## HERRAMIENTAS DE TRABAJO





## OUTILS DE TRAVAIL

Dopo  
After  
Nachher  
Después  
Après



TDR UTENSILI

DMI									
<b>Kit diserbatrice meccanica interfilare</b> (singola o doppia) Larghezza di lavoro 56 cm									
						cod. singola	euro	cod. doppia	euro
						1003030 TDR 1800 ... 3000	8.100,00	1003031 TDR 1800 ... 3000	15.880,00

ROLLHACKE singolo		ROLLHACKE doppio "BOOMERANG"							
<b>Disco anteriore rollhacke</b> Kit 2 pezzi (destro + sinistro)									
						cod. singolo	euro	cod. doppio	euro
						2050866 TDR 1800 ... 3000	1.870,00	2050865 TDR 1800 ... 3000	2.270,00

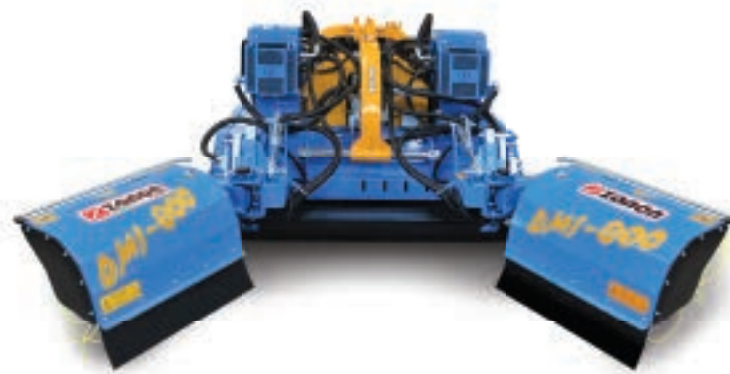

RICAMBI/SPARE PARTS

**TASTATORE LAMA SCALZATRICE / ROTOFRESA / ARATRO**



LSI / RFI / ASI



cod.

5215798

**TASTATORE MINITRINCIA MT**

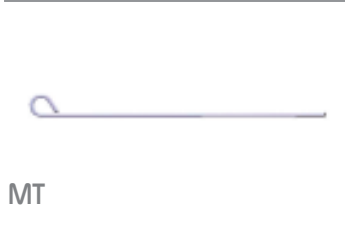

MT



cod.

5215872

**TASTATORE SPOLLONATRICE**

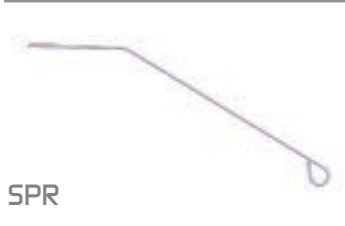

SPR



cod.

5335068

DX

5335069

SX

**TASTATORE DISCHI SCALZATORI DSL2/DSL3**



DSL2/DSL3



cod.

5215957

**TASTATORE TESTATA INTERFILARE IT Ø 50**

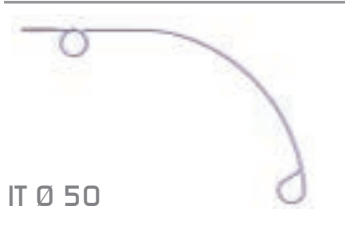

IT Ø 50



cod.

5215939

**TASTATORE TESTATA INTERFILARE IT Ø 70**

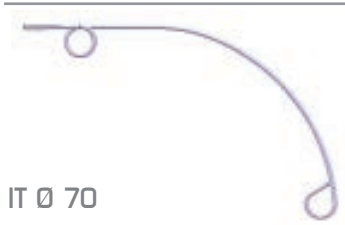

IT Ø 70



cod.

5215940

**ROLLACKER DESTRO per CST/DST-STAR/TDR**



cod.

5350207

**ROLLACKER SINISTRO per CST/DST-STAR/TDR**



cod.

5350208

**DISCO APRISOLCO per CST/DCV**



cod.

5446030

**DISCO SCALZATORE DSL**

DSL



cod.

5446038

**DISCO 50 ONDULATO Ø430 mm per DCV**

DCV



cod.

5446026



# PARTI DI RICAMBIO

SPARE PARTS

PIEZA DE REPUESTO

ERSATZTEIL

PIÈCE DE RECHANGE



ORIGINAL MADE IN ITALY

## BOBINA FILO DISERBATRICE INTERFILARE DMI 140 mt Ø 4 mm

DMI  
Ø 4 mm  
140 mt



cod.

5450063

## BOBINA FILO DISERBATRICE INTERFILARE DMI 650 mt Ø 4 mm

DMI  
Ø 4 mm  
650 mt



cod.

5450043

## BOBINA FILO TESTATA INTERFILARE IT 150 mt Ø 6 mm

IT  
Ø 6 mm  
150 mt



cod.

5450065

## BOBINA FILO SPOLLONATRICE SPR - 100 mt

SPR



cod.

5450066

## PUNTALE ANCORA APRISOLCO per CTV/DCV

CST



cod.

5446036

## VOMERE per ARATRO SCALZATORE ASI

ASI

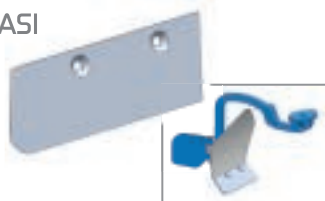

cod.

5446034

DX

5446035

SX

## RUOTA IN FERRO CST/TDR



cod.

5411034

## RUOTA IN FERRO SENZA CRESTA



cod.

5411041

## RUOTA IN FERRO INTERCEPPO CON CRESTA



cod.

5411040

## DENTE-ROTOFRESA

RFI



cod.

5223903

## MAZZA per MINITRINCIA MT



5

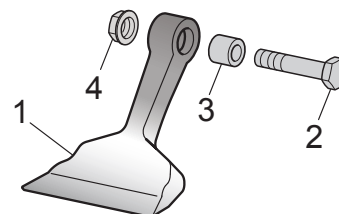

rif.	cod.	descrizione
1	5350219	Mazza 86/14 62-10-R67
2	5315007	Vite M10 per utensile
3	5215893	Bussola riduzione mazze
4	5323015	Dado M10 per utensile
5	4210305	Supporto mazza

PARTI DI RICAMBIO



IT  
IT-PRO

Type I

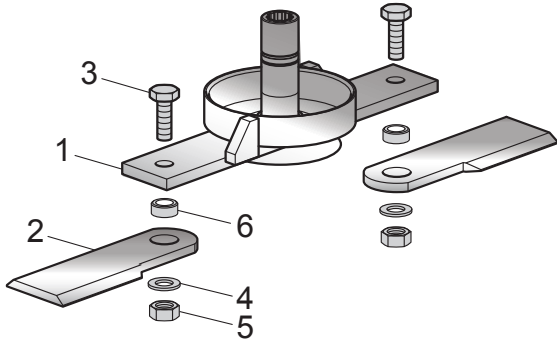

**TESTATA INTERFILARE IT Ø 50 - IT-PRO Ø 50 (Lame)**

rif.	cod.	descrizione
1	3230988	Disco portalamo Ø 50
2	5350117	Lama terminale testata interfilare
3	5315144	Vite fissaggio lama
4	5215399	Rondella bloccaggio lama
5	5323008	Dado M16 per utensile
6	5220565	Boccola di usura

**TESTATA INTERFILARE IT Ø 70 - IT-PRO Ø 70 (Lame)**

rif.	cod.	descrizione
1	3232008	Disco portalamo Ø 70
2	5350117	Lama terminale testata interfilare
3	5315144	Vite fissaggio lama
4	5215399	Rondella bloccaggio lama
5	5323008	Dado M16 per utensile
6	5220565	Boccola di usura

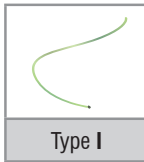

IT  
IT-PRO

Type I

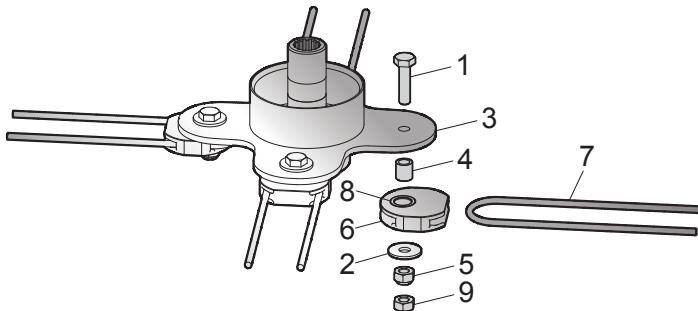

**TESTATA INTERFILARE IT Ø50/Ø70 - IT-PRO Ø50 /Ø70 (Filo)**

rif.	cod.	descrizione
1	5315007	Vite M10×40 per utensile
2	5330001	Rondella piana M10×30
3	3232599	Albero porta agganci filo Ø 50/70
4	5362032	Boccola sinterizzata
5	5323015	Dado M10 autobloccante per utensile
6	5216032	Bussola ancoraggio
7	5450065	Bobina filo testata int. IT 155 mt Ø 6 mm
8	5216033	Bussola rinforzo
9	5321035	Dado basso M10

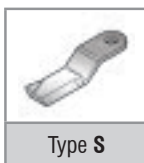

IT-M

Type S

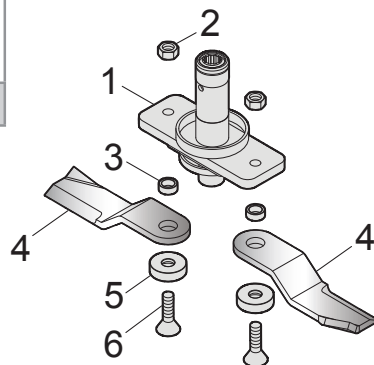

**TESTATA INTERFILARE IT-M Ø 60 / Ø 80**

rif.	cod.	descrizione
1	3232628	Supporto lame Ø60
1	3232682	Supporto lame Ø80
2	5321011	Dado M18 per utensile
3	5215678	Bussola centraggio
4	5350165	Lama
5	5215679	Centraggio inferiore
6	5304594	Vite M18×50 per utensile



LSI

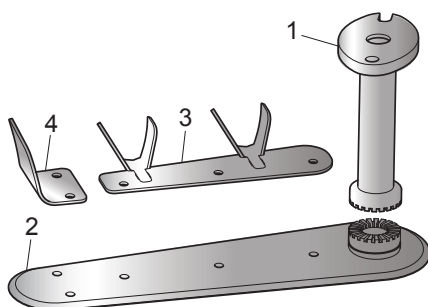

**LAMA SCALZATRICE LSI**

rif.	cod.	descrizione
1	3232289	Albero porta lama
2	3232297	Lama scalzatrice dx
2	3232354	Lama scalzatrice sx
3	3232338	Alette esplosori dx
3	3232335	Alette esplosori sx
4	5223887	Lamette laterali dx
4	5223888	Lamette laterali sx

## CONDIZIONI GENERALI DI VENDITA

**1. Le condizioni generali di vendita** si applicano a tutte le Vendite di Prodotti tra ZANON S.r.l. ed i propri Clienti, e possono essere modificate con validità a partire dalla pubblicazione sul sito web [www.zanon.it](http://www.zanon.it).

Deroghe ammissibili si hanno per differenti pattuizioni in forma scritta negli ordini o nelle conferme d'ordine. ZANON S.r.l. non si riterrà vincolata dalle Condizioni Generali del Cliente.

**2. La vendita** dovrà ritenersi conclusa:

- nel momento in cui il Cliente riceve da ZANON S.r.l. una conferma d'ordine conforme ai termini ed alle condizioni dell'ordine
- nel caso in cui il Cliente riceva da parte di ZANON S.r.l. una conferma d'ordine contenente termini difformi da quelli contenuti nell'Ordine, decorsi tre giorni lavorativi dalla data di ricezione della stessa senza che pervenga a ZANON S.r.l. contestazione scritta da parte del Cliente.
- o in assenza di conferma scritta da parte di ZANON S.r.l., nel momento in cui i prodotti saranno consegnati al Cliente.

Gli ordini regolarmente accettati da ZANON S.r.l. non potranno essere annullati e/o modificati dal Cliente senza il consenso scritto di ZANON S.r.l. Salvo diverso accordo scritto, ZANON S.r.l. non accetta resi dei Prodotti acquistati.

**3. I prezzi dei prodotti saranno quelli indicati nel Listino Prezzi aggiornato** sul sito [www.zanon.it/area-riservata/listini-prezzi](http://www.zanon.it/area-riservata/listini-prezzi) in vigore all'inoltro dell'Ordine da parte del Cliente, ovvero quelli comunicati da ZANON S.r.l. tramite Conferma d'ordine.

Il prezzo si riferisce al bene oggetto di vendita, franco fabbrica, ed ogni altro onere o accessorio è da ritenersi a parte. ZANON S.r.l. manterrà la proprietà dei prodotti fino al completo versamento del prezzo pattuito.

Cambiamenti su prezzi dovuti a cause di forza maggiore potranno essere applicati anche su Ordini confermati e non evasi, previa notifica.

**4. La consegna** avverrà entro il termine comunicato nella Conferma d'Ordine. Tale data è da considerarsi indicativa e non essenziale ai sensi dell'art. 1457 C.C., e non include i tempi di trasporto.

**5. Il pagamento** dell'ordine andrà effettuato in Euro (€) e secondo le indicazioni ed i termini pattuiti nella Conferma d'Ordine. Il pagamento cambiario graverà il cliente di commissioni ed interessi ad un tasso BCE maggiorato di 3 punti. Il mancato o ritardato pagamento, anche parziale, attribuisce a ZANON S.r.l. il diritto di sospendere immediatamente la consegna e ogni ulteriore prestazione da eseguirsi. Al Cliente moroso verranno applicati interessi di mora al tasso BCE, maggiorato di 7 punti (art.5, comma 2 D.Lgs. 231/2002)

**6. Garanzia:** ZANON S.r.l. garantisce che i prodotti forniti sono collaudati, esenti da vizi e/o difetti e sono idonei e conformi all'uso a cui sono destinati, per un periodo di 12 mesi decorrenti dalla data di consegna attestabile mediante attivazione della garanzia sul sito: [www.zanon.it/area-riservata](http://www.zanon.it/area-riservata).

Il reclamo dovrà essere inoltrato entro 8 giorni dalla scoperta del vizio, nell'utilizzo diretto ovvero entro 8 giorni dalla comunicazione del vizio al Rivenditore dal Cliente finale via raccomandata a/r o pec, corredando la pratica di opportuna documentazione fotografica (vista d'insieme ex-ante eventuale intervento di riparazione, matricola e particolari del prodotto).

I prodotti dovranno essere inviati presso la Sede ZANON S.r.l. a spese del Cliente per l'effettuazione dei necessari controlli.

La garanzia non opera per i difetti dovuti a:

- danni da trasporto*
- uso imperito od improprio dei prodotti*
- riparazioni, modifiche o manomissioni di personale non autorizzato.*
- errate modalità di installazione dei nostri prodotti o utilizzo di pezzi errati utilizzati per l'installazione.*

**ZANON S.r.l. non risponderà per motori, parti elettriche/elettroniche o elementi normalmente esposti a usura e consumo.**

La responsabilità di ZANON S.r.l. è altresì esclusa se i vizi e/o difetti erano conosciuti o conoscibili dal Cliente e/o derivino da istruzioni o pezzi e apparecchiature forniti da quest'ultimo, o per danni a persone o cose provocati da errato o superficiale utilizzo dei nostri prodotti. L'eventuale vizio del prodotto, coperto da garanzia e notificato secondo modalità descritta, sarà sanato da ZANON S.r.l. - a propria discrezione - mediante sostituzione o riparazione, ma non saranno riconosciuti indennizzi per costi di manodopera, trasporti o spese sostenute in autonomia.

Per prassi interna, tutti i ricambi saranno fatturati all'atto della spedizione con pagamento in contrassegno: il riconoscimento della garanzia, previo ricevimento e verifica del pezzo guasto, darà diritto all'accredito.

**7. I prodotti sono conformi** alla legge Italiana e alle Direttive Europee. Sarà cura dell'Importatore estero assicurarsi delle conformità cui sottostare nel Paese di destino, impegnandosi a fornire dichiarazione di conformità, il manuale d'istruzioni, l'eventuale documentazione tecnica e la propria garanzia. La documentazione tecnica aggiornata è disponibile sul sito web: [www.zanon.it](http://www.zanon.it), ed a questa il Cliente è tenuto a far riferimento.

**8. ZANON S.r.l. avrà facoltà di risolvere, ai sensi art. 1456 CC, mediante comunicazione via raccomandata a/r o pec, la singola vendita nel caso di mancato ritiro o ricezione dei beni o nell'eventualità di inadempimento delle obbligazioni previste dai punti: 5; 7; 9.**

**9. I diritti di proprietà intellettuale** sono di totale ed esclusiva proprietà di ZANON S.r.l., ed il Cliente si obbliga a non compiere alcun atto incompatibile con essi, quindi non utilizzerà o registrerà Marchi simili o confondibili con i Marchi ZANON, utilizzando invece Marchi e Diritti ZANON in ottemperanza alle istruzioni della Casa Madre e per i fini di cui alle presenti Condizioni di Vendita.

**10. Il trattamento dei dati personali** avverrà secondo quanto disposto dal Reg. UE 679/2016, nel rispetto della normativa vigente, in relazione all'attività commerciale ed obblighi contrattuali. Il titolare del trattamento dei dati personali è ZANON S.r.l.

**11. Per ogni controversia è competente il foro di Padova, e per tutti i contratti, la legge applicabile sarà quella Italiana.**

## GENERAL TERMS AND CONDITIONS OF SALE

**1. These general terms and conditions of sale** shall apply to all Sales of Products between ZANON S.r.l. and its Customers and may be amended with effect from their publication on [www.zanon.it](http://www.zanon.it) website. Exceptions shall be granted following different written agreements set out in orders or order confirmations. The Customer's General Terms and Conditions shall not be considered to be binding on ZANON S.r.l.

**2. A sale** shall be deemed to have been concluded:

- When the Customer receives an order confirmation from ZANON S.r.l. that complies with the terms and conditions set out in the order;
- Upon three business days having elapsed since receipt of the order confirmation without ZANON S.r.l. receiving a written objection from the Customer if the Customer receives an order confirmation from ZANON S.r.l. containing terms and conditions other than those set out in the Order; or
- Upon the products being delivered to the Customer if no written confirmation is received from ZANON S.r.l.

Orders regularly accepted by ZANON S.r.l. may not be cancelled and/or changed by the Customer without ZANON S.r.l.'s written consent. Unless otherwise agreed in writing, ZANON S.r.l. shall not accept returns of purchased Products.

**3. The prices of the products will be those indicated in the updated Price List** on the site [www.zanon.it/en/reserved-area/price-list](http://www.zanon.it/en/reserved-area/price-list) in force at the time the Order is placed by the Customer, or those communicated by ZANON S.r.l. by means of Order Confirmation. The price shall refer to the item being sold, ex-works, with any other cost or accessory being considered as not included. ZANON S.r.l. shall retain ownership of the Products until the agreed price shall have been paid in full. Changes in prices due to force majeure events may also be applied to confirmed and unfulfilled Orders, subject to prior notice.

**4. Delivery** shall take place within the date as stated in the Order Confirmation. This date shall be considered to be approximate and not essential for the purposes of Section 1457 of the Italian Civil Code, and shall not include transport time.

**5. Order payment** shall be made in EUR (€) and in accordance with the instructions and deadline as set out in the Order Confirmation. Payment by promissory note shall cause the customer to incur commissions and interest at an ECB rate plus 3 points. Non-payment or delayed payment, whether in part or in whole, shall entitle ZANON S.r.l. to suspend forthwith delivery as well as any other service to be provided. Customers in arrears shall be charged default interest at the ECB rate plus 7 points (Article 5(2) of Legislative Decree 231/2002).

**6. Warranty:** ZANON S.r.l. hereby guarantees that the Products supplied are tested, free from defects and/or faults and are suitable for and compliant with their intended use for a period of 12 months from the date of delivery, as certified following activation of the warranty on [www.zanon.it/en/reserved-area](http://www.zanon.it/en/reserved-area) website.

Any complaint must be submitted within 8 days after discovery of the defect, in the case of direct use, or within 8 days after notification of the defect to the Retailer by the end Customer by registered letter with return receipt or by certified email [PEC], complete with adequate photographic evidence (overall view before any repair work, serial number and product details). The Products must be sent to ZANON S.r.l. headquarters at the Customer's expense in order that the necessary checks may be performed.

The warranty shall not apply to defects cause by:

- i) *damage during transportation*
- ii) *inappropriate or improper use of the products*
- iii) *repairs, changes or tampering by unauthorised personnel.*
- iv) *incorrect installation procedure or use of incorrect parts during installation.*

**ZANON S.r.l. shall not be liable for fair wear and tear of motors, electrical/electronic parts or elements.**

ZANON S.r.l. shall also not be held liable (i) if the Customer was aware of or knowledgeable about any defects and/or faults and/or if such defects and/or faults are deemed to arise from instructions or parts and equipment supplied by the Customer, or (ii) for damage to persons or property caused by improper or careless use of our products. Any defect in the product - covered under the warranty and notified as described - shall be remedied by ZANON S.r.l., at its sole discretion, by replacement or repair, but no compensation shall be granted for labour costs, transport or expenses incurred independently.

In accordance with corporate policies, all spare parts shall be invoiced at the time of dispatch: acknowledgement of warranty shall, subject to receipt of and checks performed on the faulty part, entitle the Customer to receive credit.

**7. The products comply** with Italian law and European Directives. It shall be the responsibility of the foreign importer to ensure product compliance in the country of destination, undertaking to provide a declaration of conformity, an operation manual, any technical documentation and its own warranty. Updated technical documentation is available on [www.zanon.it](http://www.zanon.it), to which the Customer shall be required to refer.

**8. Pursuant to section 1456 of the Italian Civil Code, ZANON S.r.l. shall, by serving a notice to be sent by registered letter with return receipt or by email, have the right to terminate individual sales in the event of failure to collect or receive the goods or in the event of failure to comply with the obligations under 5; 7; 9 hereof.**

**9. The intellectual property rights** shall be the total and exclusive property of ZANON S.r.l., and the Customer undertakes to refrain from engaging in any conduct deemed to be in contrast with such rights. As a result, the Customer shall not use or register any Trademark similar to or capable of being confused with ZANON's Trademarks, using instead ZANON's Trademarks and Rights in compliance with ZANON's instructions and for the purposes set forth hereunder.

**10. Personal data** shall be processed in accordance with the provisions of Regulation EU 679/2016, in compliance with current legislation, in relation to commercial activity and contractual obligations. The data controller of personal data shall be ZANON S.r.l.

**11. The court of Padua shall have jurisdiction over any dispute, while Italian law shall apply to all contracts.**

## ALLGEMEINE VERKAUFSBEDINGUNGEN

**1. Die Allgemeine Verkaufsbedingungen** gelten für alle Verkäufe von Produkten zwischen der Firma ZANON S.r.l. und deren Kunden. Die Bedingungen können mit Gültigkeit ab dem Zeitpunkt der Veröffentlichung auf der Website [www.zanon.it](http://www.zanon.it) geändert werden. Anderslautende Ausnahmeregelungen müssen in den Bestellungen oder Auftragsbestätigungen in Schriftform festgelegt werden. ZANON S.r.l. ist nicht an die Allgemeinen Geschäftsbedingungen der Kunden gebunden.

**2. Der Verkauf** gilt als abgeschlossen:

- sobald der Kunde eine Auftragsbestätigung von ZANON S.r.l. erhält, die den Auftragsbedingungen entspricht
- für den Fall, dass der Kunde eine Auftragsbestätigung von ZANON S.r.l. erhält, die vom Auftrag abweichende Bedingungen enthält, nach Ablauf von drei Werktagen ab dem Datum des Erhalts derselben, ohne dass ein schriftlicher Einspruch des Kunden bei ZANON S.r.l. eingegangen ist.
- wenn keine schriftliche Bestätigung durch ZANON S.r.l. vorliegt, in dem Moment, in dem die Produkte dem Kunden geliefert werden.

Aufträge, die von ZANON S.r.l. ordnungsgemäß angenommen werden, können vom Kunden nicht ohne schriftliche Zustimmung von ZANON S.r.l. storniert und / oder geändert werden. Vorbehaltlich anderslautender schriftlicher Vereinbarungen, akzeptiert ZANON S.r.l. keine Rücksendungen von gekauften Produkten.

**3. Die Preise der Produkte sind die, die in der aktualisierten Preisliste** auf der Website [www.zanon.it/de/reservierter-bereich/preisliste](http://www.zanon.it/de/reservierter-bereich/preisliste) angegeben sind, die zum Zeitpunkt der Bestellung des Kunden in Kraft ist, oder die, die von ZANON S.r.l. durch die Auftragsbestätigung mitgeteilt werden. Der Preis bezieht sich auf den Verkaufsgegenstand ab Werk. Sonstige Kosten oder Aufpreise sind gesondert zu berücksichtigen. ZANON S.r.l. behält sich das Eigentum an den Produkten bis zur vollständigen Bezahlung des vereinbarten Preises vor. Preisänderungen aufgrund höherer Gewalt können auch auf bestätigte und nicht abgewickelte Aufträge angewandt werden, sofern eine Benachrichtigung vorliegt.

**4. Die Lieferung** erfolgt innerhalb der in der Auftragsbestätigung mitgeteilten Frist. Diese Frist ist gemäß Art. 1457 italienisches ZGB [C.C.] als richtungswesend und nicht wesentlich zu betrachten und beinhaltet nicht die Transportzeit.

**5. Die Zahlung** des Auftrags erfolgt in Euro (€) gemäß den Angaben und Bedingungen, die in der Auftragsbestätigung vereinbart wurden. Dem Kunden werden Bearbeitungsgebühren und Zinsen in der Höhe des um 3 Punkte erhöhten EZB-Leitzinssatzes berechnet. Nichtzahlung oder Zahlungsverzug, auch teilweise, berechtigen ZANON S.r.l. zur sofortigen Einstellung der Lieferung sowie jeder weiteren Leistung. Dem säumigen Kunden werden Verzugszinsen in der Höhe des EZB-Leitzinssatzes zuzüglich 7 Punkte berechnet (Artikel 5, Absatz 2 italienische Gesetzesverordnung [D.Lgs.] 231/2002).

**6. Garantie:** ZANON S.r.l. gewährleistet, dass die gelieferten Produkte geprüft, frei von Mängeln und / oder Fehlern sind und für den bestimmungsmäßigen Zweck geeignet sind, und zwar für einen Zeitraum von 12 Monaten ab dem Lieferdatum, das durch die Aktivierung der Garantie auf der Website: [www.zanon.it/de/reservierter-bereich](http://www.zanon.it/de/reservierter-bereich) nachweisbar ist.

Die Reklamation muss innerhalb von 8 Tagen nach dem Entdecken des Mangels bei direkter Nutzung erfolgen oder innerhalb von 8 Tagen nach der Mitteilung des Mangels an den Händler seitens des Endkunden per Einschreiben mit Rückschein oder per Mail an die zertifizierte Mail-Adresse. Zu diesem Zweck müssen die Unterlagen mit entsprechender Fotodokumentation (Gesamtansicht vor einer eventuellen Reparatur, Seriennummer und Produktdetails) beigelegt werden. Die Produkte müssen auf Kosten des Kunden zur Überprüfung an den Firmensitz von ZANON S.r.l. geschickt werden.

Die Garantie gilt nicht für Mängel aufgrund von:

- Transportschäden*
- mangelhafter oder unsachgemäßer Verwendung der Produkte*
- Reparaturen, Änderungen oder Eingriffe durch nicht autorisiertes Personal.*
- falschen Installationsweisen unserer Produkte oder Verwendung falscher Teile, die für die Installation verwendet wurden.*

**ZANON S.r.l. haftet nicht für Motoren, elektrischen / elektronischen Teile oder Komponenten, die verschleißanfällig sind.**

Zudem haftet ZANON S.r.l. auch nicht, wenn Mängel und / oder Fehler dem Kunden bekannt waren oder erkennbar gewesen sein müssten und / oder wenn sie auf Anweisungen oder Teile und Ausrüstungen zurückzuführen sind, die von Letzterem bereitgestellt wurden. Zudem haftet ZANON S.r.l. nicht für Personen- oder Sachschäden, die durch falsche oder fehlerhafte Benutzung der eigenen Produkte hervorgerufen worden sind. Jeder Produktmangel, der unter die Garantie fällt und in der beschriebenen Weise gemeldet wurde, wird von ZANON S.r.l. - nach eigenem Ermessen - durch Austausch oder Reparatur behoben, wobei jedoch keine Entschädigungen für Arbeit, Transport oder selbst getragene Kosten anerkannt werden.

Intern wird es so gehandhabt, dass alle Ersatzteile zum Zeitpunkt des Versands in Rechnung gestellt werden: Bevor die Garantie anerkannt wird, wird der fehlerhafte Teil nach seinem Eingang geprüft und erst dann erhält Kunde eine Gutschrift.

**7. Die Produkte entsprechen** dem italienischen Recht und den Europäischen Richtlinien. Es liegt in der Verantwortung des ausländischen Importeurs, die Konformität im Bestimmungsland sicherzustellen. Zu diesem Zweck ist dieser verpflichtet, eine Konformitätserklärung, das Benutzerhandbuch, etwaige technischen Unterlagen und seine Garantie zur Verfügung zu stellen. Die aktualisierten technischen Unterlagen sind auf der Website [www.zanon.it](http://www.zanon.it) verfügbar. Der Kunde ist verpflichtet, darauf Bezug zu nehmen.

**8. ZANON S.r.l. ist befugt, den einzelnen Verkauf gemäß Art. 1456 ZGB per Einschreiben mit Rückschein oder Mail an die zertifizierte Mail-Adresse aufzuheben, wenn die Waren nicht abgeholt oder nicht empfangen werden oder wenn die in unter den Punkten 5, 7, 9 vorgesehenen Verpflichtungen nicht erfüllt werden.**

**9. Die geistigen Eigentumsrechte** sind das vollständige und ausschließliche Eigentum von ZANON S.r.l. Der Kunde ist verpflichtet, keine Handlungen vorzunehmen, die damit unvereinbar sind. Er darf also keine Marken verwenden oder eintragen zu lassen, die den Marken von ZANON ähnlich oder mit diesen verwechselbar sind. Stattdessen muss er die Marken und Rechte von ZANON verwenden, die den Anweisungen des Mutterunternehmens und den in den Verkaufsbedingungen festgelegten Zwecken entsprechen.

**10. Die Verarbeitung der personenbezogenen Daten** erfolgt in Übereinstimmung mit den Bestimmungen der EU-Verordnung 679/2016, in Übereinstimmung mit der aktuellen Gesetzgebung, in Bezug auf die Geschäftstätigkeit und die vertraglichen Verpflichtungen. Der Verantwortliche für die Verarbeitung der personenbezogenen Daten ist ZANON S.r.l.

**11. Das Gericht von Padua ist für alle Streitigkeiten zuständig. Für die Verträge findet italienisches Recht Anwendung.**

## CONDICIONES GENERALES DE VENTA

**1. Las condiciones generales de venta** se aplican a todas las Ventas de Productos entre ZANON S.r.l. y sus Clientes, y pueden ser modificadas con validez a partir de la publicación en la página web [www.zanon.it](http://www.zanon.it).

Las excepciones admisibles se obtienen mediante otros acuerdos por escrito en los pedidos o en las confirmaciones de pedido. ZANON S.r.l. no estará sujeta a las Condiciones Generales del Cliente.

**2. La venta** deberá considerarse concluida:

- cuando el Cliente recibe una confirmación de pedido de ZANON S.r.l. de acuerdo con los términos y condiciones de pedido;
- cuando el Cliente recibe una confirmación de pedido de ZANON S.r.l. que contenga otros términos diferentes de aquellos contenidos en el Pedido, transcurridos tres días laborables desde la fecha de recepción del mismo, sin que ZANON S.r.l. reciba reclamación por escrito del Cliente;
- o si no hubiera una confirmación por escrito de ZANON S.r.l., en el momento en que los productos serán entregados al Cliente.

Los pedidos que ZANON S.r.l. ha aceptado no podrán ser anulados ni modificados por el Cliente sin el consentimiento por escrito de ZANON S.r.l. ZANON S.r.l. no acepta devoluciones de los Productos comprados, salvo acuerdo en contrario por escrito.

**3. Los precios de los productos serán los indicados en la Lista de precios Zanon** actualizada en el sitio web [www.zanon.it/es/area-reservada/lista-de-precios](http://www.zanon.it/es/area-reservada/lista-de-precios), vigente a la fecha de envío del pedido, o bien el precio comunicado por Zanon en la confirmación del pedido.

El precio se refiere a la mercancía vendida, franco fábrica (Ex Works); otros gastos o costes adicionales serán cargados en cuenta por separado. ZANON S.r.l. se reserva la propiedad de los productos hasta el pago total del precio convenido. Los cambios en los precios a causa de fuerza mayor también se podrán aplicar a Pedidos confirmados y no servidos, previa notificación.

**4. Los productos se entregarán** en el plazo comunicado en la Confirmación de Pedido. Esta fecha debe considerarse indicativa y no vinculante de conformidad con el art. 1457 del Código Civil italiano, y no incluye los tiempos de transporte.

**5. El pago** del pedido se realizará en euros (€) y según las indicaciones y plazos convenidos en la Confirmación de Pedido. Las comisiones e intereses debido al pago de la letra de cambio correrán por cuenta del cliente al tipo aplicado por el BCE más 3 puntos porcentuales. En caso de incumplimiento o demora en el pago, incluso parcial, ZANON S.r.l. tendrá derecho a suspender de inmediato la entrega y cualquier otro servicio que deba cumplir. Los intereses de demora se aplicarán al cliente moroso al tipo aplicado por el BCE, más 7 puntos porcentuales (art. 5, apdo. 2 del DLeg. italiano 231/2002).

**6. Garantía:** ZANON S.r.l. garantiza que los productos suministrados están probados, libres de vicios y/o defectos y son adecuados y conformes al uso al que están destinados, durante un período de 12 meses a partir de la fecha de entrega que debe confirmarse activando la garantía en la página web: [www.zanon.it/es/area-reservada](http://www.zanon.it/es/area-reservada).

La reclamación deberá enviarse antes de los 8 días siguientes a la fecha de descubrimiento del vicio, durante el uso directo, o antes de los 8 días siguientes a la fecha de la comunicación del vicio al Distribuidor por parte del Cliente final mediante carta certificada con acuse de recibo, o correo electrónico certificado, acompañando el expediente con la respectiva documentación fotográfica (vista general antes y después de posibles reparaciones, número de serie y detalles del producto). Los productos deberán enviarse al domicilio de ZANON S.r.l. por cuenta del Cliente para la realización de los controles necesarios.

La garantía no es válida para los defectos debidos a:

- daños de transporte*
- uso no autorizado o inadecuado de los productos*
- reparaciones, modificaciones o alteraciones realizadas por personal no autorizado.*
- métodos incorrectos de instalación de nuestros productos o uso de piezas inadecuadas para la instalación.*

**ZANON S.r.l. no se asume ninguna responsabilidad por motores, piezas eléctricas/electrónicas o elementos normalmente expuestos a desgaste o consumibles.**

ZANON S.r.l. tampoco es responsable si los vicios y/o defectos eran conocidos o debían ser conocidos por el Cliente y/o derivan de instrucciones o piezas y equipos proporcionados por este último, ni tampoco de daños a personas o bienes causados por un uso incorrecto o superficial de nuestros productos. Cualquier vicio en el producto, amparado por garantía y notificado de la manera descrita, será subsanado por ZANON S.r.l. - a su discreción - mediante sustitución o reparación, pero no se reconocerán indemnizaciones por gastos de mano de obra, transporte u otros gastos en los que se haya incurrido.

Por cuestiones internas, todas las piezas de repuesto serán facturadas en el momento del envío: el reconocimiento de la garantía, tras recibir y verificar la pieza defectuosa, dará derecho al crédito.

**7. Los productos son conformes** a la ley italiana y a las Directivas Europeas. El importador extranjero tendrá la responsabilidad de asegurarse del respeto de la conformidad en el país de destino, comprometiéndose a proporcionar una declaración de conformidad, el manual de instrucciones, posible documentación técnica y su propia garantía. La documentación técnica actualizada está disponible en la página web: [www.zanon.it](http://www.zanon.it), y el Cliente deberá tomarla como referencia.

**8. ZANON S.r.l. tendrá la facultad de resolver la venta, de conformidad con el art. 1456 del Código Civil italiano y mediante carta certificada con acuse de recibo o correo electrónico certificado, si el cliente no recogiera o recibiera la mercancía o en caso de incumplimiento de las obligaciones establecidas en los puntos: 5; 7; 9.**

**9. Los derechos de propiedad intelectual** son propiedad total y exclusiva de ZANON S.r.l., y el Cliente se compromete a no realizar ningún acto incompatible con los mismos, por lo que no utilizará ni registrará Marcas similares ni confundibles con las Marcas ZANON, sino que utilizará las Marcas y Derechos ZANON respetando las instrucciones de la empresa matriz y para los fines a los que se refieren estas Condiciones de Venta.

**10. Los datos personales** serán tratados de acuerdo con lo establecido en el Reglamento UE 679/2016, en cumplimiento de la normativa vigente, en relación con la actividad comercial y las obligaciones contractuales. El responsable del tratamiento de datos personales es ZANON S.r.l.

**11. En caso de litigios será competente el tribunal de Padua, y para todos los contratos, la ley aplicable será la ley italiana.**

## CONDITIONS GÉNÉRALES DE VENTE

**1. Les conditions générales de vente** s'appliquent à toutes les ventes de produits conclues entre ZANON S.r.l. et ses clients; toute éventuelle modification prendra effet à dater de sa publication sur le site web [www.zanon.it](http://www.zanon.it). Pour être admises, toutes dérogations doivent être formalisées par des accords écrits dans les commandes ou dans les confirmations de commande. Les conditions générales du Client ne seront pas contraignantes pour ZANON S.r.l.

**2. La vente** sera considérée comme conclue:

- au moment où le client reçoit de ZANON S.r.l. une confirmation de commande conforme aux termes et aux conditions de la commande;
- au cas où le client recevrait de ZANON S.r.l. une confirmation de commande contenant des termes différents de ceux spécifiés dans la commande, une fois écoulé le délai de trois jours ouvrables à dater de sa réception à défaut de contestation écrite du client parvenue à ZANON S.r.l.;
- ou à défaut de confirmation écrite de la part de ZANON S.r.l., au moment où les produits seront livrés au client.

Les commandes régulièrement acceptées par ZANON S.r.l. ne pourront être annulées et/ou modifiées par le client à défaut de l'autorisation écrite de ZANON S.r.l. Sauf accord différent devant faire l'objet d'un écrit, ZANON S.r.l. n'accepte pas les rendus des produits achetés.

**3. Les prix à jour des produits sont indiqués sur le tarif des prix ZANON** dans le site [www.zanon.it/fr/zone-reserve/liste-de-prix](http://www.zanon.it/fr/zone-reserve/liste-de-prix) en vigueur au moment de l'envoi de la commande par le client, ou ceux communiqués par ZANON S.r.l. dans la confirmation de commande. Le prix se réfère au bien faisant l'objet de la vente, départ usine; toutes autres charges ainsi que tous autres frais accessoires seront considérés à part. ZANON S.r.l. conservera la propriété des produits jusqu'au versement du montant total du prix convenu. Tous changements apportés sur les prix imputables à des causes de force majeure pourront être appliqués également sur les commandes confirmées mais auxquelles il n'a pas encore été donné suite, moyennant communication préalable.

**4. La livraison** aura lieu dans le délai communiqué dans la confirmation de commande. Cette date doit être considérée comme indicative et non essentielle au sens de l'article 1457 du Code civil italien et elle ne comprend pas le temps de transport.

**5. Le paiement** de la commande devra être effectué en Euros (€) et selon les indications et les délais convenus dans la confirmation de commande. Le paiement par lettre de change comportera, à la charge du client, l'application de commissions et d'intérêts à un taux BCE majoré de 3 points. En cas de tout défaut ou retard de paiement, même partiel, à ZANON S.r.l. sera reconnu le droit de suspendre immédiatement la livraison non moins que toutes autres prestations devant être exécutées. Au client retardataire seront appliqués des intérêts moratoires au taux BCE, majoré de 7 points (article 5, alinéa 2 du décret législatif italien 231/2002)

**6. Garantie:** ZANON S.r.l. garantit que les produits fournis sont testés, exempts de vices et/ou de défauts et appropriés et conformes à l'usage auquel ils sont destinés, pour une période de 12 mois à compter de la date de livraison attestée moyennant l'activation de la garantie sur le site: [www.zanon.it/fr/zone-reserve](http://www.zanon.it/fr/zone-reserve).

La réclamation devra être envoyée dans les 8 jours pour tout délai à dater de la découverte du vice, en cas d'utilisation directe, ou dans les 8 jours à compter de la communication du vice au Revendeur par le client final, par lettre recommandée A/R ou courrier électronique certifié PEC; elle devra être accompagnée d'une documentation photographique adéquate (vue d'ensemble ex-ante, éventuelle intervention de réparation, numéro de matricule et détails du produit). Les produits devront être expédiés au siège de ZANON S.r.l. aux frais du client aux fins de l'exécution des contrôles nécessaires.

La garantie ne joue pas pour les défauts imputables aux faits suivants:

- dommages occasionnés par le transport;*
- usage imprudent ou inapproprié des produits;*
- réparations, modifications ou manipulations effectuées par un personnel non autorisé;*
- modalités d'installation erronées de nos produits ou utilisation de matériels inappropriés pour l'installation.*

**ZANON S.r.l. ne répondra pas des moteurs, des parties électriques/électroniques ou des éléments normalement soumis à l'usure et à la consommation.**

La responsabilité de ZANON S.r.l. n'est pas engagée si le client connaissait, ou pouvait connaître, les vices et défauts, ou si ceux-ci seraient imputables à des instructions ou des matériels qu'il aurait fournis, ou encore pour tous dommages causés aux personnes et aux choses dérivant d'un usage impropre ou imprudent de nos produits. Il appartiendra à ZANON S.r.l. de remédier à l'éventuel vice du produit couvert par la garantie et communiqué conformément aux modalités spécifiées, moyennant, à sa seule discrétion, son remplacement ou sa réparation, mais aucune indemnisation pour les coûts de main-d'œuvre, de transport ou de frais autonomement exposés à défaut d'autorisation ne sera reconnue.

Par pratique interne, toutes les pièces de rechange seront facturées au moment de l'expédition: la reconnaissance de la garantie, suite à la réception et la vérification de la pièce défectueuse, donnera droit au remboursement par virement.

**7. Les produits seront conformes** à la loi italienne et aux directives européennes. Il appartiendra à l'importateur étranger de s'assurer des normes et règlements auxquels se conformer dans le pays de destination, et de s'engager à fournir toute déclaration de conformité, le manuel d'instructions, l'éventuelle documentation technique ainsi que sa propre garantie. La documentation technique mise à jour est à disposition sur le site web: [www.zanon.it](http://www.zanon.it) et le client est tenu à y faire référence.

**8. ZANON S.r.l. aura la faculté, au sens de l'article 1456 du Code civil italien, de résilier une vente moyennant communication par lettre recommandée A.R. ou PEC, en cas de non retrait ou de réception des biens, ou en cas d'inexécution des obligations visées aux points 5, 7 et 9.**

**9. Les droits de propriété intellectuelle** appartiennent exclusivement à ZANON S.r.l., et le client s'interdit d'accomplir tout acte incompatible avec lesdits droits, à savoir d'utiliser ou d'enregistrer des marques similaires ou susceptibles de prêter à confusion avec les Marques ZANON, et il s'oblige à utiliser les marques et les droits ZANON dans le respect des instructions de la maison-mère et pour les finalités spécifiées dans les présentes conditions de vente.

**10. Le traitement des données personnelles** sera effectué conformément aux dispositions du Règlement UE 679/2016 dans le respect de la législation en vigueur, relativement à l'activité commerciale et aux obligations contractuelles. Le titulaire du traitement des données personnelles est ZANON S.r.l.

**11. Toute controverse sera soumise à la compétence du Tribunal de Padoue et pour tous les contrats la loi applicable sera la loi italienne.**

---

## RICHIESTA DI PRIMO AVVIAMENTO

---

### TERMINI DI ASSISTENZA VALIDI SOLO PER L'ITALIA

Il servizio di primo avviamento permette di usufruire di un supporto tecnico specializzato, fornito da personale qualificato ZANON per minimizzare le problematiche di messa in funzione della macchina.

### In cosa consiste il servizio di primo avviamento

Il servizio di primo avviamento ZANON è un servizio accessorio alla vendita dei nostri prodotti mediante il quale, dopo la fase di montaggio della macchina, si può usufruire della consulenza di tecnici specializzati per evitare problematiche dovute ad un'errata installazione e messa in opera.

### Le principali attività del tecnico

- Accurata verifica delle condizioni di installazione della macchina e il rispetto delle norme di installazione redatte dal costruttore.
- Collegamento della macchina al trattore.
- Suggerimenti e consigli relativi alle migliori impostazioni da utilizzare sulla macchina e sui dispositivi di controllo, al fine di operare le selezioni più corrette alla tipologia di lavoro.
- Istruzioni sulla regolare manutenzione della macchina per ridurre i costi di mantenimento e poter lavorare in totale sicurezza.

### Procedura di attivazione del servizio

La richiesta di attivazione del servizio può essere inoltrata con un preavviso di almeno 10 giorni lavorativi per mail a [assistenza.tecnico@zanon.it](mailto:assistenza.tecnico@zanon.it)

Successivamente alla richiesta la ZANON invierà un apposito modulo che dovrà essere compilato in tutte le sue parti e pervenire per mail a [assistenza.tecnico@zanon.it](mailto:assistenza.tecnico@zanon.it), in caso contrario la richiesta verrà annullata.

Al ricevimento del modulo compilato, ZANON farà una valutazione e invierà un preventivo in cui viene indicato il costo e i termini del servizio.

Note aggiuntive:

- È sempre necessaria la presenza in loco del personale tecnico del concessionario di riferimento.
- La macchina oggetto della richiesta di assistenza dovrà essere completamente assemblata in tutte le sue parti.
- I mezzi e le spese di trasporto sono a carico del cliente (Dealer) così come le eventuali spese di manodopera e le spese accessorie (pasti, trasferimenti, pernottamento, etc.)

Per ogni ulteriore approfondimento contattare il proprio rivenditore di zona.









Via Madonnetta, 30 - 35011 CAMPODARSEGO (PD) ITALY  
Tel. +39 049 9200433 | mail: info@zanon.it

zanon.it    

**Dati tecnici ed immagini sono indicativi.**

ZANON, nello sforzo di dare un prodotto innovativo sempre più aderente alle esigenze dei propri clienti, si riserva di apportare modifiche costruttive e tecniche in qualsiasi momento e senza alcun preavviso.

**Technical data and images are indicative.**

ZANON is committed to constantly improving its products to meet the needs of the sector. It therefore reserves the right to make construction and technical changes at any time and without notice.

**Technische Daten und Fotos sind indikativ**

ZANON ist bestrebt, ein innovatives Produkt anzubieten, das immer näher an den Bedürfnissen seiner Kunden liegt, und behält sich das Recht vor, Design und technische Änderungen jederzeit und ohne Vorankündigung vorzunehmen.

**Los datos técnicos y las imágenes son indicativos.**

En el esfuerzo de brindar a sus clientes un producto cada vez más cercano a sus exigencias, ZANON se reserva de aportar modificaciones constructivas y técnicas en todo momento y sin previa antelación.

**Les données techniques et les images sont indicatifs.**

Dans l'effort de proposer un produit répondant de plus en plus aux exigences de ses clients, ZANON se réserve le droit de apporter des modifications constructives et techniques en tout moment et sans préavis.